

david k lawyers pty ltd

DISCLOSURE DOCUMENT

“PARKINSON RESIDENCES”

| | |
|-------------|--|
| Schedule 1 | Buyer Information |
| Schedule 2 | Disclosure Statement |
| Schedule 3 | Disclosure Plan |
| Schedule 4 | Administration Agreements |
| Schedule 5 | Caretaking Agreement |
| Schedule 6 | Community Management Statement |
| Schedule 7 | Budgets and Contributions |
| Schedule 8 | Schedule of Features & Finishes, |
| Schedule 9 | Power of Attorney Disclosure Statement |
| Schedule 10 | Letting Agreement |
| Schedule 11 | Development Plans |
| Schedule 12 | Origin Embedded Network Agreement |

The Buyer acknowledges having received and read this Disclosure Document before signing the contract.

.....
Buyer

Date / /

david k lawyers
lvl 12 300 queen st
brisbane qld 4000
australia

tel: 07 3102 2583 fax: 07 3839 3006

Schedule 1 – Buyer Information

1. Independent legal and financial advice

This schedule contains important information about:

- (a) Parkinson Residences Development; and
- (b) the contract you may sign to purchase a lot or proposed lot in Parkinson Residences Development (**Contract**).

You must not rely only on this information before deciding whether to sign the Contract. This information is not a substitute for obtaining your own independent legal and financial advice.

Before you sign the Contract, we recommend that you obtain independent legal and financial advice so that you are fully aware of your obligations under the Contract and your capacity to perform those obligations and settle the Contract.

A reference to a clause in this Schedule is a reference to a clause in the Contract.

2. What are you buying?

You are buying a proposed lot (or apartment) in a community titles scheme.

A community titles scheme contains individually owned lots and common property areas (for example, driveways, lifts, pedestrian access ways, recreation areas and landscaped areas).

A community titles scheme is administered by a body corporate.

The members of the body corporate are all the owners of the lots in the scheme.

The community titles scheme in which you are buying a lot is or will be called the “Parkinson Residences Community Titles Scheme” (**Parkinson Residences Scheme**) but we may change the name of the Scheme.

The body corporate for the Parkinson Residences Scheme is or will be called the “Body Corporate for Parkinson Residences Community Titles Scheme” (**Body Corporate**) but we may change the name of the Body Corporate.

When you sign the Contract Parkinson Residences Scheme may not be established. We may have to do certain things for that to occur. If that is the case, this is commonly known as buying a lot “off- the-plan” because the lot you are buying does not exist at the time you sign the Contract.

3. Cooling-off period

In Queensland, a buyer of residential property is entitled to a five business day cooling-off period unless the buyer waives the cooling-off period.

The cooling-off period starts on the day you (or your agent) receive the Contract signed by you and us. If that happens on a non-business day, then the cooling-off period will start on the next business day. The cooling-off period ends at 5:00pm on the fifth business day.

If you terminate the Contract during the cooling-off period, we are entitled to retain a termination penalty equivalent to 0.25% of the purchase price from the deposit. The balance of the deposit must be refunded to the Buyer within 14 days following termination.

4. Parkinson Residences Development

Parkinson Residences Development will be undertaken in a single stage.

The timing of completion will be dependent upon a number of factors including the level of pre-sales that can be achieved, the availability of funding for Parkinson Residences Development, changes in market conditions and the general economic circumstances (**Development Conditions**). The Development Conditions may delay or prevent the carrying out of Parkinson Residences Development

It is intended (which intention may change) that Parkinson Residences Development will comprise two residential apartment buildings containing approximately 29 residential townhouses and associated facilities.

It is intended (which intention may change) that the subdivision process for Parkinson Residences Development will generally be as follows:

- (a) The Land will be reconfigured by proposed SP 321898 to create the Scheme Land; and
- (b) the Scheme Land will be subdivided by way of building format plan to create 29 residential lots and common property of Parkinson Residences Scheme

The name of Parkinson Residences Scheme may be changed.

You accept that the design of Parkinson Residences Development (or any part of it) is an on-going process and that the detailed design of areas and services may not be possible until construction has commenced or is well advanced and nearing completion. As a result, the plans and documents that have been included in this Disclosure Document may change. For example, any dimensions, areas or distances on any plan may be different when surveyed after construction has been completed and this may mean (for example) that the shape or dimensions of volumetric or common property areas may change (including being reduced).

Parkinson Residences Scheme will be established after we cause:

- (a) the building format survey plan to be registered in the Department of Natural Resources and Mines to subdivide the building to create the lot you are buying and other lots and the common property for Parkinson Residences Scheme; and
- (b) the community management statement (**CMS**) to be recorded in the Department of Natural Resources and Mines, which statement contains details about Parkinson Residences Scheme including lot entitlements and the by-laws that will apply to Parkinson Residences Scheme.

Schedule 6 contains a copy of the CMS.

The Contract is conditional on these things occurring (clause 5.3).

5. Settlement date and time of the essence

You will be required to complete the purchase on the settlement date.

In accordance with clause 22.1, the settlement date is the day which is fourteen (14) days after the day on which the Seller notifies the Buyer that the Community Titles Scheme has been established and that an indefeasible title for the Lot has been created.

In any event settlement must not take place earlier than fourteen (14) days after the Seller gives advice to the Buyer that the Scheme has been established.

Settlement must take place no later than 5 years from the Contract Date (**Sunset Date**).

On the settlement date you must pay the purchase price less any deposit and subject to adjustments for outgoings (for example, rates, body corporate contributions, insurance and land tax) (clause 3.5). We may adjust for land tax on the basis of what we must pay to the Office of State Revenue in respect of the Lot (clause 3.5 (e)).

Under the Contract, time is of the essence (clause 30.3). This means that you must perform your obligations on the due date including paying the deposit on time and settling the Contract on the settlement date. If you do not do that or fail to comply with any other essential term, we may be entitled to exercise certain rights including terminating the Contract and retaining the deposit (clauses 31.2 and 31.3).

We must be in a position to settle the Contract on the settlement date. If not or we fail to comply with any other essential term, you may be entitled to exercise certain rights including terminating the Contract and recovering the deposit (clauses 32.2 and 32.3).

6. Seller's termination right if condition not satisfied by Scheme Date

Subject to the provisions of the Contract we must use reasonable endeavours to commence the construction of the building and establish Parkinson Residences Scheme as soon as reasonably possible (clauses 7.1(a) and 5.3(b)).

We must use reasonable endeavours to establish Parkinson Residences Scheme by the date fifty-nine (59) months from the Contract Date (**Scheme Date**).

If that requirement is not satisfied by the Scheme Date, we may terminate the Contract (clause 5.3(c)). If that occurs, the deposit will be refunded to you together with any interest earned on the investment of any cash deposit you have paid but you will not have any claim or action against us. This means that you will not be entitled to any compensation for any costs you have incurred (for example, your legal fees or costs in providing a bank guarantee instead of a cash deposit).

7. Seller's other termination rights

We must obtain development approvals and we must obtain construction funding to commence and complete construction of the building containing the lot you are buying. We cannot unconditionally commit to such things without knowing that we can terminate the Contract:

- (a) if we do not obtain all the necessary development approvals on satisfactory conditions (acting reasonably);
 - (b) if by 3 years from the Contract Date we do not secure a satisfactory level of pre-sales to make Parkinson Residences viable or to apply for or obtain construction funding for Parkinson Residences; or
-

- (c) if by 3 years from the Contract Date we do not obtain construction finance on satisfactory terms (acting reasonably).

This is why the termination rights in clauses 5.1 (Approvals) and 5.2 (Pre-sales and finance) have been included.

If the Contract is terminated by us under clauses 5.1 or 5.2, the deposit will be refunded to you together with any interest earned on the investment of any cash deposit you have paid but you will not have any claim or action against us. This means that you will not be entitled to any compensation for any costs you have incurred (for example, your legal fees or costs in providing a bank guarantee instead of a cash deposit).

We have other termination rights under clauses 5.4 and 30.1.

8. Your termination rights

You may have a right to terminate the Contract if we fail to comply with any essential term of the Contract (clause 31.1).

Under the *Body Corporate and Community Management Act 1997* you may have a right to terminate the Contract if settlement does not occur by the Sunset Date.

9. Changes to the Lot and Parkinson Residences Development

Subject to the provisions of the Contract, we must use reasonable endeavours to cause the building and the lot to be constructed substantially in accordance with the development approvals, the Disclosure Plan in Schedule 3, the Development Plans in Schedule 11 and the Schedule of Finishes in Schedule 8 (clause 7.1(b)).

The plans have been prepared by our consultants and they contain dimensions, measurements or areas which are estimates only because the building and the lot have not been constructed (clause 7.1(c)).

During the development and construction process we may encounter issues, difficulties or complications and we cannot enter into the Contract with you unless we have some flexibility to make changes.

We are entitled to make the following changes:

- (a) changes to the lot or the building (clause 4.5);
- (b) changes to the CMS (clause 4.7);
- (c) changes to Body Corporate Agreements (clause 4.6); and
- (d) the other changes mentioned (clause 4.7).

Also, you cannot object to the things mentioned in clause 4.8.

We may change the area of the lot shown on the Disclosure Plan in Schedule 3 by up to 5% (clause 4.5(a)).

10. Defects

You will have 90 days from the settlement date to notify us of defects in the lot or any chattels sold to you. If we fail to fix defects, our liability is limited to damages for reasonable rectification costs (clause 7.2(a)).

There are certain defects specifically identified in respect of which you cannot take issue with (clause 7.2(c)).

Except as provided for in clause 7.2, you cannot object to defects (clause 7.2(e)).

11. Body Corporate Agreements and other matters

When Parkinson Residences Scheme is established, we may be the owner of some or all of the lots in Parkinson Residences Scheme and may control the Body Corporate.

At that time, we may cause the Body Corporate to hold meetings and cause it to enter into the Body Corporate Agreements referred to in clause 9.1(a). You will see details of some of those agreements disclosed in Schedule 4 and Schedule 5.

We may cause the Body Corporate to grant leases, licences or easements over common property areas for our benefit or for the benefit of another person or cause the Body Corporate to enter into leases, licence or easements for the benefit of Parkinson Residences Scheme (clause 9.1(b)).

We may receive money or benefits if the Body Corporate enters into a Body Corporate Agreement or grants or enters into a lease, licence or easement and you consent to that occurring (clause 9.1(c)). For example, we may sell the management and letting rights for Parkinson Residences Scheme. We will be entitled to those proceeds not the Body Corporate.

12. Letting agreements

We may elect to sell the management and letting rights for Parkinson Residences Scheme to an operator or cause them to be granted to us or a related entity (**Operator**) who may operate a letting agent's business (**Letting Scheme**).

If we elect to sell the management and letting rights for Parkinson Residences Scheme: -

- (i) We are not selling the lot to you on the basis that you must participate in any Letting Scheme. Unless you have agreed to do so, you are not required to join any Letting Scheme;
 - (ii) If you agree to join any Letting Scheme, you will need to enter into a letting appointment with the Operator and the Operator will need to comply with relevant disclosure requirements; and
 - (iii) Before you agree to do so, you should consider the benefits, risks and costs associated with being a member of any Letting Scheme and take independent legal, valuation and financial advice.
-

13. Exclusive Use areas

If the sale includes the exclusive use of an area of common property, it will be identified in the reference schedule of the Contract, the CMS or the special conditions to the Contract.

It is intended that the relevant area will be allocated to you by way of an exclusive right of use or licence under a by-law (that is, it will not form part of the title to the lot) and you consent to that occurring. Clause 9.2(c) gives us the right to make changes to the exclusive use arrangements.

14. Views

You acknowledge that land surrounding Parkinson Residences Scheme may be developed in the future, resulting in views from Parkinson Residences Scheme or from part of the building being interrupted or impeded.

You accept that we do not warrant that any views represented or depicted on any marketing material will be maintained in the future and you agree that you will not be entitled to make any claim against us if views are interrupted or impeded (clause 6.6).

15. Your consent

Under the Contract, you give your consent to:

- (a) our dealing with the land, the lot or the Contract (for example, borrowing money on the security of the land or the lot) (clauses 23.1 and 23.2);
- (b) if we elect to do so, we may lodge an application for the approval of the Foreign Investment Review Board (FIRB) if you are a foreign person (clause 29.3(d)); and
- (c) our using your personal information for certain purposes as stated in clause 19.

16. FIRB approval

Unless we have obtained a pre-approval to sell lots in Parkinson Residences Scheme to foreign persons, if you are a non-Australian resident (foreign person) and you have indicated that in the reference schedule of the Contract, you will be required to make an application for the approval of the FIRB within 7 days from the date of the Contract (clause 29.3(c)). The provisions in clause 7 deal with that approval process.

Where you do not exercise a right to terminate under the FIRB condition, you will be deemed to have warranted to us that you have FIRB approval and the FIRB condition will no longer apply.

17. Sale by buyer

Due to the scale of Parkinson Residences Development, it is possible that we may not have sold all of the lots in the Scheme prior to settlement and will be continuing to sell lots following settlement.

You agree that prior to settlement, you cannot transfer, sell or assign your interest in the contract or transfer or sell the lot without our consent, which consent may be granted subject to reasonable conditions (special condition 23.3(b)).

You also agree that following settlement, you cannot sell or transfer the lot until 12 months after settlement or earlier if agreed by us, without our consent, which consent may be granted subject to reasonable conditions (special condition 23.3(c)).

You agree to indemnify us for any loss we may suffer if you breach these requirements (special condition 23.3(d)).

18. Special conditions

Schedule 1 in the Contract will contain any special conditions to the Contract.

19. Statutory disclosure for lot

Under Queensland law applying to the sale of proposed lots or existing lots, there are certain things that we must disclose to you before you sign the Contract.

Those disclosure obligations may arise under the *Body Corporate and Community Management Act 1997* (Qld).

That disclosure is made to you in the disclosure statement in Schedule 2.

We have given you a power of attorney disclosure statement in Schedule 9. That schedule discloses the purposes for which we may exercise your voting rights (once you become the owner of the lot after settlement) during the period of one year after Parkinson Residences Scheme has been established or where the lot exists at the date of the Contract, one year after the date of the Contract (clause 9.3).

If you sell the lot during that period you must ensure that the buyer gives us a similar power of attorney (clause 9.3(f)). If you do not do that and we incur loss or damage, for example, because it affects our ability to complete the development or sell lots, you must indemnify (or compensate) us for that loss or damage (clause 9.3(g)).

Schedule 2 – Disclosure Statement

Disclosure statement to Buyer by Seller under with section 213 of the *Body Corporate and Community Management Act 1997 (Qld)*

To:
..... (Buyer)

Address:
.....

From: Highway Developments No.1 Pty Ltd A.B.N. 42 625 791 844 (Seller)

Address: C/- David K Lawyers, Level 12, 300 Queen Street, Brisbane QLD 4000

Proposed Lot No: (Lot)

Background

The Seller proposes to enter into a contract (**Contract**) with the Buyer for the sale to the Buyer of the Lot in Parkinson Residences community titles scheme (**Parkinson Residences Scheme**).

Disclosure

The Seller discloses to the Buyer the following:

(a) Identification of Lot:

The Lot, subject to any changes permitted under the provisions of the Contract, is identified on the Disclosure Plan in Schedule 3.

(b) Date by which the Seller must settle the Contract:

Settlement of the Contract must take place no later than the date five (5) years from the Contract Date.

(c) Annual contributions reasonably expected to be payable to the body corporate for Parkinson Residences Scheme (Body Corporate) by the owner of the Lot:

Schedule 7 contains details of the annual contributions payable by the owner of the Lot for the first financial year after Parkinson Residences Scheme is established.

For subsequent financial years the annual contributions will be determined by the Body Corporate and may increase due to escalating costs.

(d) Details of any proposed engagement of a person as a body corporate manager or service contractor for Parkinson Residences Scheme proposed to be entered into after the establishment of Parkinson Residences Scheme (including the terms of the engagement, the estimated cost of the engagement to the Body Corporate and the proportion of the cost to be borne by the owner of the Lot):

- (1) The Seller proposes to cause the Body Corporate to engage a body corporate manager for Parkinson Residences Scheme, being QBS Strata Management Pty Ltd. The Seller may change the body corporate manager. The terms of the engagement, other than the provisions of the code of conduct deemed to be
-

included in those terms under section 118 of the *Body Corporate and Community Management Act 1997 (Qld) (Act)*, will substantially be in accordance with the form of Administration Agreement in Schedule 4. The estimated cost of the engagement of the body corporate manager during the first financial year and the proportion of the cost to be borne by the owner of the Lot in respect of the first financial year following the establishment of Parkinson Residences Scheme is in Schedule 7.

- (2) The Seller proposes to cause the Body Corporate to engage a service contractor as a caretaker for Parkinson Residences Scheme. The caretaker may be the Seller or an entity associated with the Seller. The terms of the engagement to provide caretaking services, other than the provisions of the code of conduct deemed to be included in those terms under section 118 of the Act, will substantially be in accordance with the form of Caretaking Agreement in Schedule 5. The estimated cost of the engagement of the service contractor during the first financial year and the proportion of the cost to be borne by the owner of the Lot in respect of the first financial year following the establishment of Parkinson Residences Scheme is in Schedule 7.
- (3) The Seller may cause the Body Corporate to engage a service contractor to provide services in relation to the supply or administration of any utility service (for example, electricity, hot water, gas, communications, fire alarm monitoring and response, building communication portal or lift maintenance). At the date of this disclosure statement, the terms of any such engagement, the estimated cost of the engagement to the Body Corporate and the proportion of the cost to be borne by the owner of the Lot have not been determined. However, allowances have been made in the administrative fund budget disclosed in Schedule 7 for certain service contractor engagements.

Any service contractor engagement may include the following:

- (i) lot owners and occupiers and the Body Corporate must pay for the consumption or use of any utility service, which cost may be dependent upon the amount of consumption or use and the relevant charge for consumption or use from time to time;
 - (ii) the rate or charge for consumption will generally be in accordance with the market cost or range for the utility service and a minimum charge may apply;
 - (iii) meters or other utility infrastructure may measure the usage of any utility service by each lot owner, occupier or the Body Corporate;
 - (iv) the Body Corporate or the service contractor will render accounts to lot owners or occupiers for the consumption or use of any utility service;
 - (v) lot owners and occupiers may be required to pay a deposit and administration and other charges for the provision of any utility service (for example, late payment, connection, disconnection and reconnection charges and debt recovery charges);
 - (vi) the Body Corporate may pay the service contractor certain remuneration or charges which may be reviewed annually (for example, in accordance with CPI rises or a fixed percentage increase, whichever is the higher);
 - (vii) the service contractor may install plant and equipment or other utility infrastructure and retain ownership of it, and register a security interest over it; and
 - (viii) in the event that the engagement is terminated prior to the end of its
-

term (which may be up to 10 years or longer), the service contractor may remove any plant and equipment or other utility infrastructure unless the Body Corporate agrees to pay to the service contractor an amount to purchase it, which amount may be at an agreed value at a certain point in time or be determined by valuation.

(e) Details of any proposed authorisation of a person as a letting agent for Parkinson Residences Scheme proposed to be given after the establishment of Parkinson Residences Scheme (including the terms of the authorisation):

The Seller proposes to cause the Body Corporate to authorise a person as a letting agent for Parkinson Residences Scheme. The letting agent may be the Seller or an entity associated with the Seller. The terms of the authorisation, other than the provisions of the code of conduct deemed to be included in those terms under section 118 of the Act, will substantially be in accordance with the form of Letting Agreement in Schedule 10. The owner of the Lot (and owners of other lots) must pay a letting fee and other charges to the letting agent (as set out in any letting appointment entered into between the owner and the letting agent), in the event that the Lot owner wishes to use the services of the letting agent.

The Seller is not selling any furniture package with the Lot unless the Buyer has elected to purchase a furniture package from the Seller under the Contract. If the Buyer decides to let out the Lot, the Buyer may have to furnish it at its cost.

(f) Details of Body Corporate assets proposed to be acquired by the Body Corporate after the establishment or change of Parkinson Residences Scheme:

Nil.

(g) Proposed community management statement for Parkinson Residences Scheme:

The proposed Community Management Statement for Parkinson Residences Scheme accompanies this Statement in Schedule 6. Parkinson Residences Scheme will not be a subsidiary scheme.

(h) Regulation module proposed to apply to Parkinson Residences Scheme:

Body Corporate and Community Management (Accommodation Module) Regulation 2008 (Qld).

(i) Other matters prescribed under the regulation module applying to Parkinson Residences Scheme:

Nil

This Disclosure Statement is dated the 20th day of August 2020

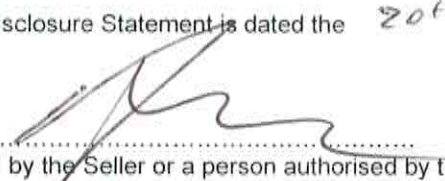
.....
Signed by the Seller or a person authorised by the Seller

Schedule 3 – Disclosure Plan

[Note: The building format plan in this Schedule is in draft form only and subject to a final survey. The plan must be read and construed subject to the provisions of the Contract. The location and area of the Lot and other characteristics and dimensions of the Lot may change as permitted by the provisions of the Contract.]

PERMANENT MARKS

| PM | ORIGIN | BEARING | DIST | NO | TYPE |
|----|--------|---------|------|----|------|
| | | | | | |

REFERENCE MARKS

| STN | TO | ORIGIN | BEARING | DIST |
|-----|----|--------|---------|------|
| | | | | |

Reinstatement Report

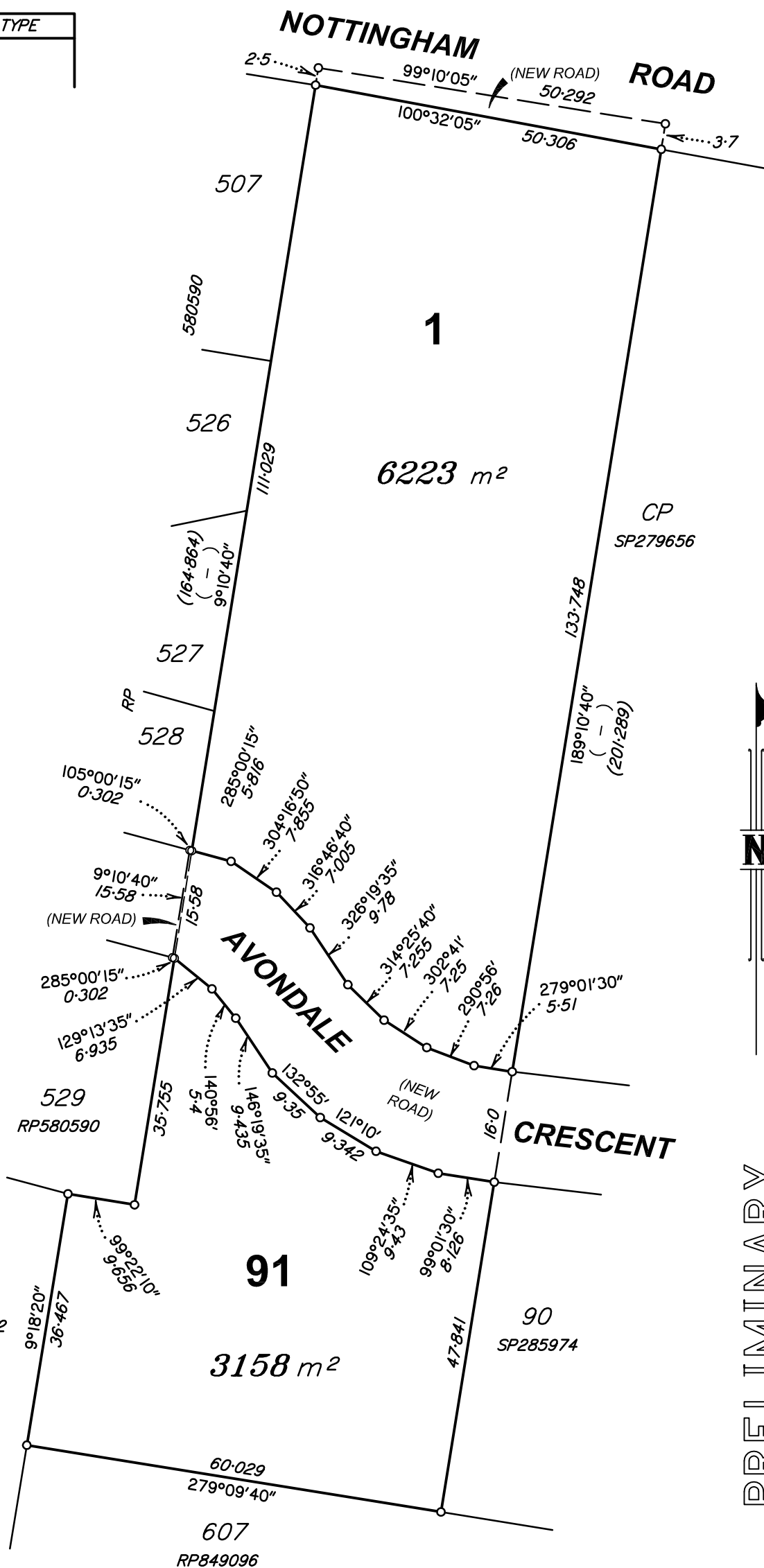

Total Area of New Road
1100 m²

Peg placed at all new corners, unless otherwise stated.



PRELIMINARY

Scale 1:750 - Lengths are in Metres.

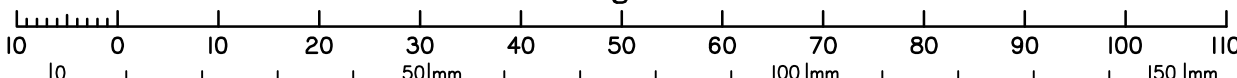

State copyright reserved.

Wolter Consulting Group Pty Ltd (ACN 147 343 084) hereby certify that this plan has been prepared as a preliminary copy of the proposed subdivision from supplied design drawings. Final areas and dimensions are subject to Council approval, field survey and registration with the Department of Natural Resources, Mines and Energy.

Plan of Lots 1 & 91

Cancelling Lot 146 on RP88878 & Lot 9 on RP850590

LOCAL GOVERNMENT: **BRISBANE CITY**

LOCALITY: **PARKINSON**

Scale: **1:750**

Format: **STANDARD**

PROPOSED
SP321898
VERSION A - 18-08-2020

Meridian:

Survey Records: *No*

Cadastral Surveyor

Date

WARNING : Folded or Mutilated Plans will not be accepted.
Plans may be rolled.
Information may not be placed in the outer margins.

(Dealing No.)

4. Lodged by

(Include address, phone number, email, reference, and Lodger Code)

| I. Existing | | Created | | |
|-----------------|---|----------|------------------|---------------------|
| Title Reference | Description | New Lots | Road | Secondary Interests |
| | Lot 146 on RP88878 Lot 9 on RP850590 | I & 91 | New Rd New Rd | _____ |

PRELIMINARY

6. Building Format Plans only.
I certify that :
* As far as it is practical to determine, no part of the building shown on this plan encroaches onto adjoining lots or road,
* Part of the building shown on this plan encroaches onto adjoining * lots and road

.....
Cadastral Surveyor/Director* Date
*delete words not required

7. Lodgement Fees :

| | |
|------------------|----------|
| Survey Deposit | \$ |
| Lodgement | \$ |
| New Titles | \$ |
| Photocopy | \$ |
| Postage | \$ |
| TOTAL | \$ |

| | |
|--------|---------|
| I & 91 | Por 404 |
| Lots | Orig |

2. Orig Grant Allocation :

3. References :
Dept File :
Local Govt :
Surveyor : 20-0291S

5. Passed & Endorsed :

By : Wolter Consulting Group Pty Ltd
Date :
Signed :
Designation : Liaison Officer

8. Insert Plan Number **SP321898**

Reinstatement Report

Subject boundaries have been reinstated from existing monuments from SP321898. The reinstatement of the subject boundaries directly follows the precedent established by this plan and dimensions agree within established survey accuracies.

Base Parcel Area

6223 m²

Peg placed at all new corners, unless otherwise stated.

Buildings are 2 Storey Buildings.

The Seller, under the Contract Terms, is entitled to make Variations to the Lot, including to its location, area, size, dimensions and elevation. Without limitation, if the area of the Lot on the Plan is not more than 5% different to the total area of the Lot as shown on this Plan, the Variation is deemed to be a Permitted Variation and the Buyer cannot Object.

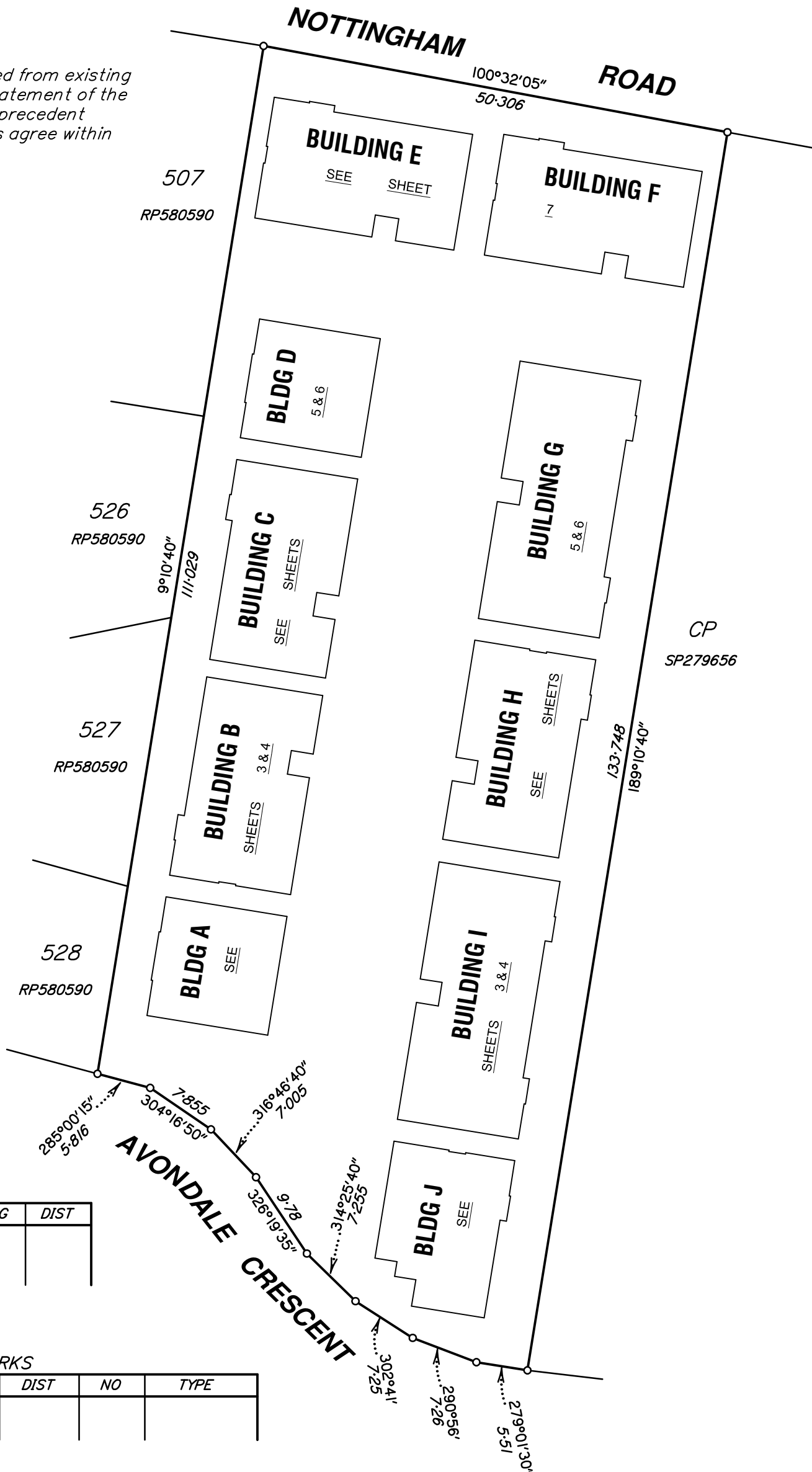

REFERENCE MARKS

| STN | TO | ORIGIN | BEARING | DIST |
|-----|----|--------|---------|------|
| | | | | |

PERMANENT MARKS

| PM | ORIGIN | BEARING | DIST | NO | TYPE |
|----|--------|---------|------|----|------|
| | | | | | |

Scale 1:500 - Lengths are in Metres.

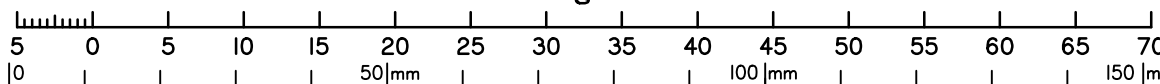

Wolter Consulting Group Pty Ltd (ACN 147 343 084) hereby certify that this plan has been prepared by us as a preliminary copy of the proposed subdivision from supplied design drawings provided by Heran Building Group on 04-08-2020.

Final areas are subject to design changes, Council approval, construction, field survey and registration with the Department of Natural Resources, Mines and Energy and may differ from those shown on this plan.

Plan of Lots 1-29 & Common Property

Cancelling Lot 1 on SP321898

LOCAL GOVERNMENT: BRISBANE CITY

LOCALITY: PARKINSON

Meridian:

Survey Records: No

Scale: 1:500

Format: BUILDING

PROPOSED SP321895

VERSION A - 18-08-2020

PRELIMINARY

**WARNING : Folded or Mutilated Plans will not be accepted.
Plans may be rolled.
Information may not be placed in the outer margins.**

(Dealing No.)

4. Lodged by

(Include address, phone number, email, reference, and Lodger Code)

| | | | | |
|-----------------|-------------------|-----------|-------|---------------------|
| I. Existing | | Created | | |
| Title Reference | Description | New Lots | Road | Secondary Interests |
| | Lot 1 on SP321898 | 1-29 & CP | _____ | _____ |

P R E L I M I N A R Y

Date of Development Approval: ____-____-____

6. Building Format Plans only.

I certify that :
 * As far as it is practical to determine, no part of the building shown on this plan encroaches onto adjoining lots or road;
~~* Part of the building shown on this plan encroaches onto adjoining * lots and road~~

.....
 Cadastral Surveyor / ~~Director~~ * Date

*delete words not required

7. Lodgement Fees :

| | |
|-----------------|-----------------|
| Survey Deposit | \$ |
| Lodgement | \$ |
|New Titles | \$ |
| Photocopy | \$ |
| Postage | \$ |
| TOTAL | \$ |

8. Insert Plan Number **SP321895**

| | |
|-----------|---------|
| 1-29 & CP | Por 404 |
| Lots | Orig |

2. Orig Grant Allocation :

3. References :
 Dept File :
 Local Govt :
 Surveyor : 20-0291S

5. Passed & Endorsed :

By: **Wolter Consulting Group Pty Ltd**
 Date :
 Signed :
 Designation : **Liaison Officer**

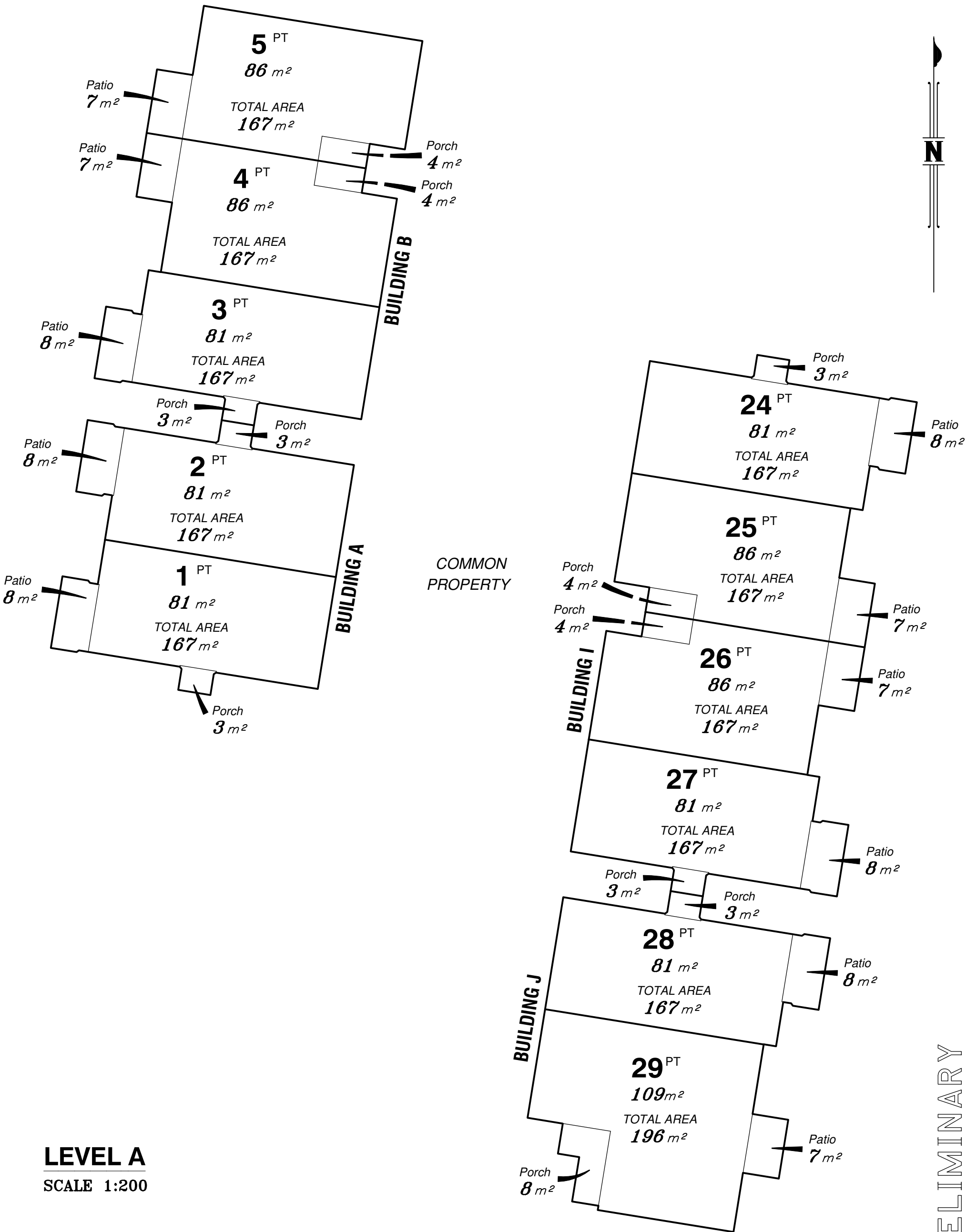

LEVEL A
SCALE 1:200

Scale 1:200 - Lengths are in Metres.

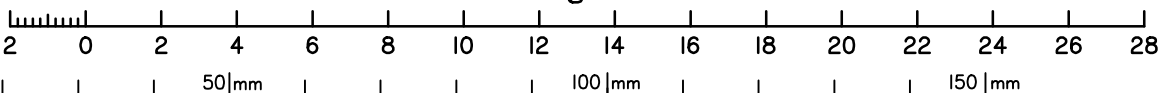

State copyright reserved.

Insert Plan Number **SP321895**

PRELIMINARY

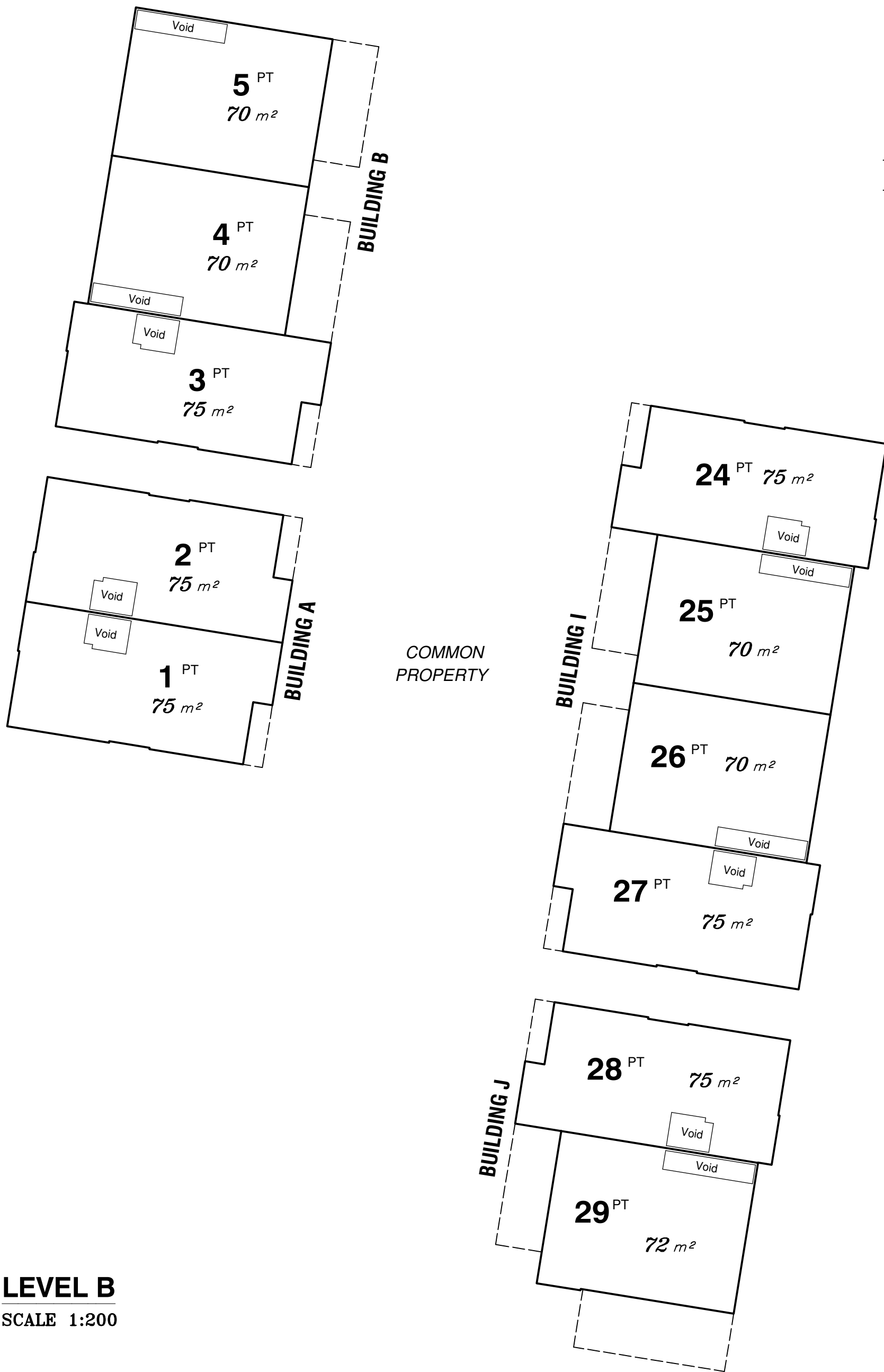

LEVEL B
SCALE 1:200

--- Denotes Outline of Level Below

Scale 1:200 - Lengths are in Metres.

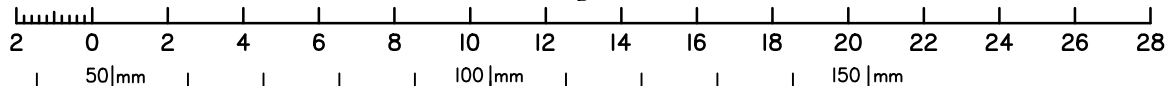

State copyright reserved.

Insert
Plan
Number

SP321895

PRELIMINARY

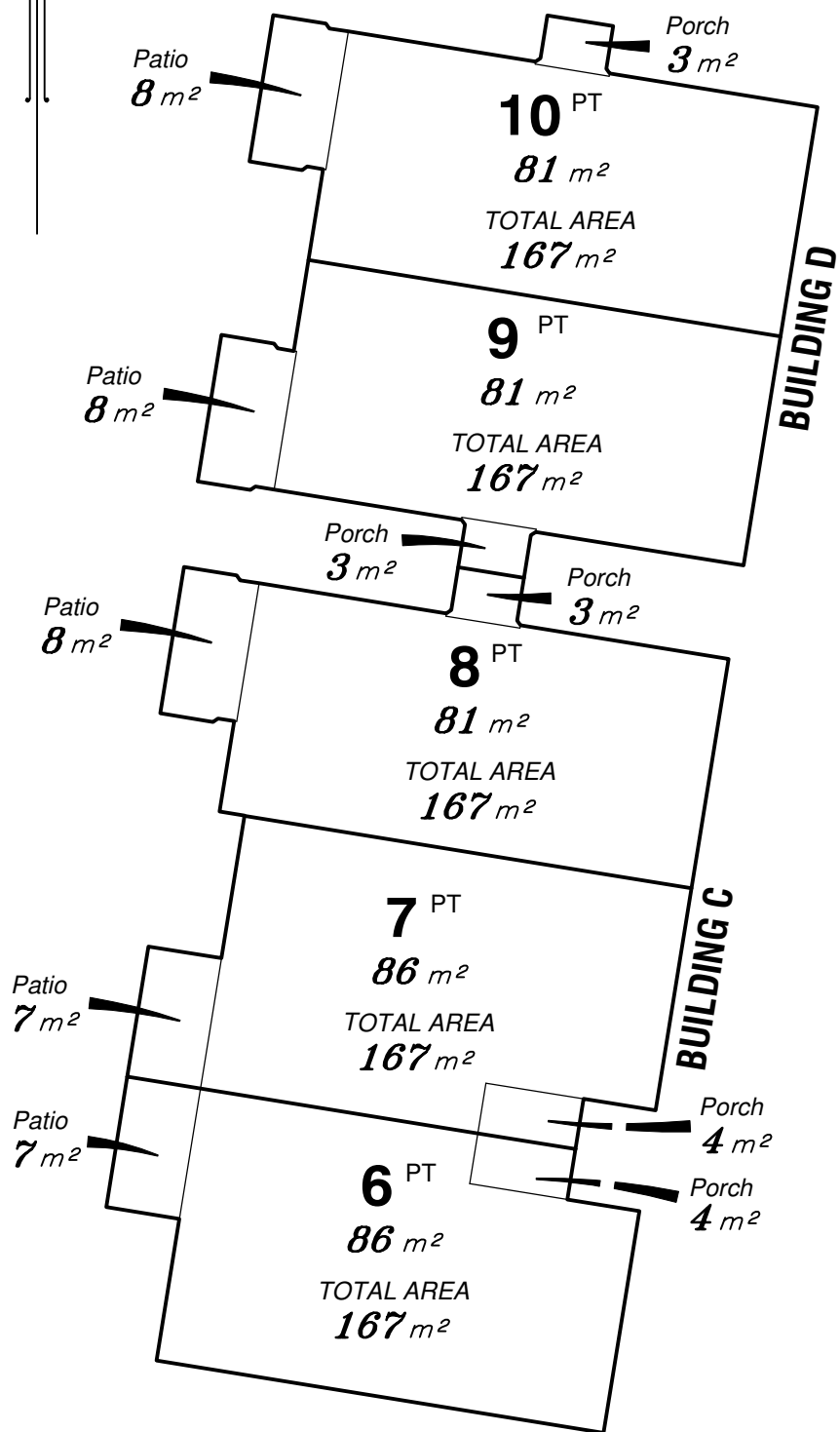

COMMON
PROPERTY

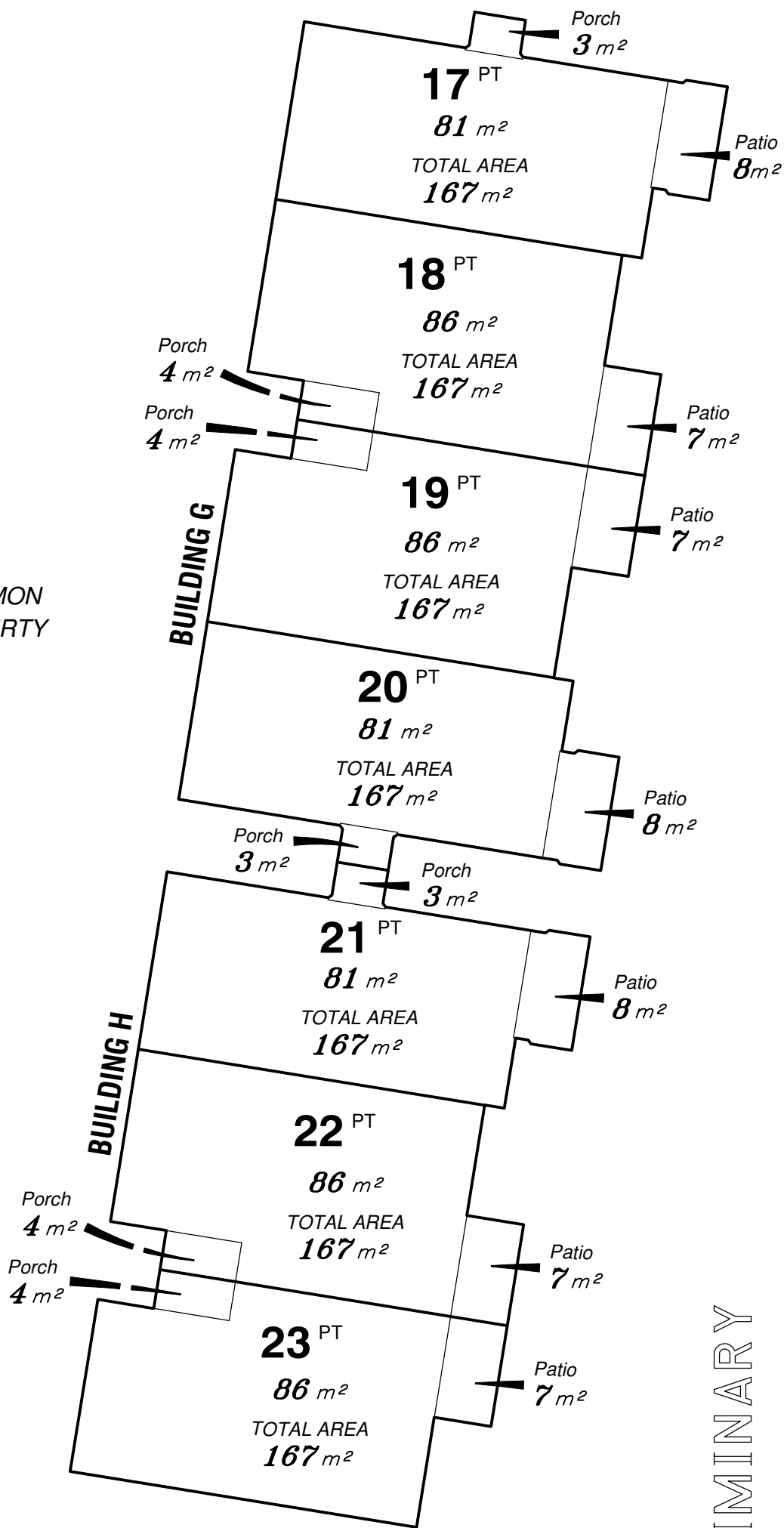

LEVEL A

SCALE 1:200

PRELIMINARY

Scale 1:200 - Lengths are in Metres.

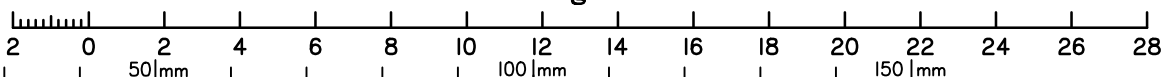

State copyright reserved.

Insert
Plan
Number

SP321895

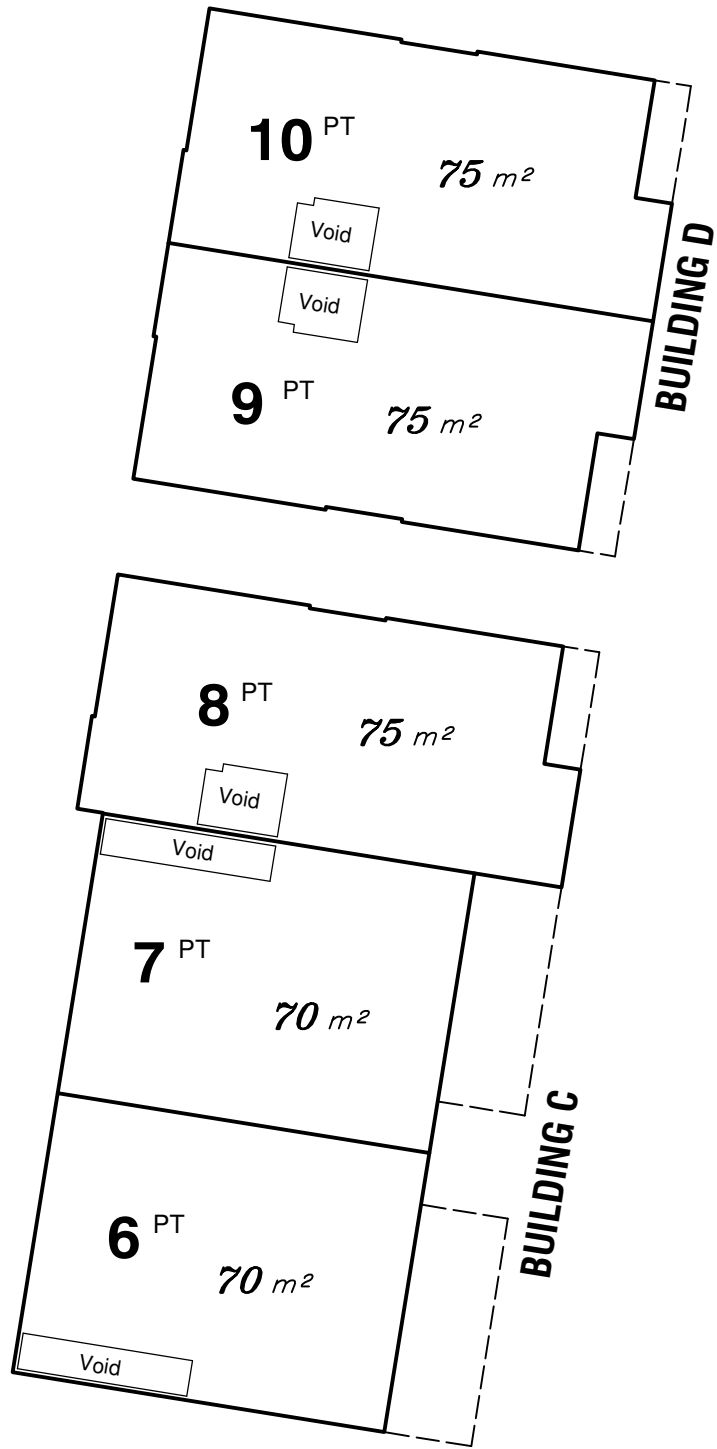

COMMON
PROPERTY

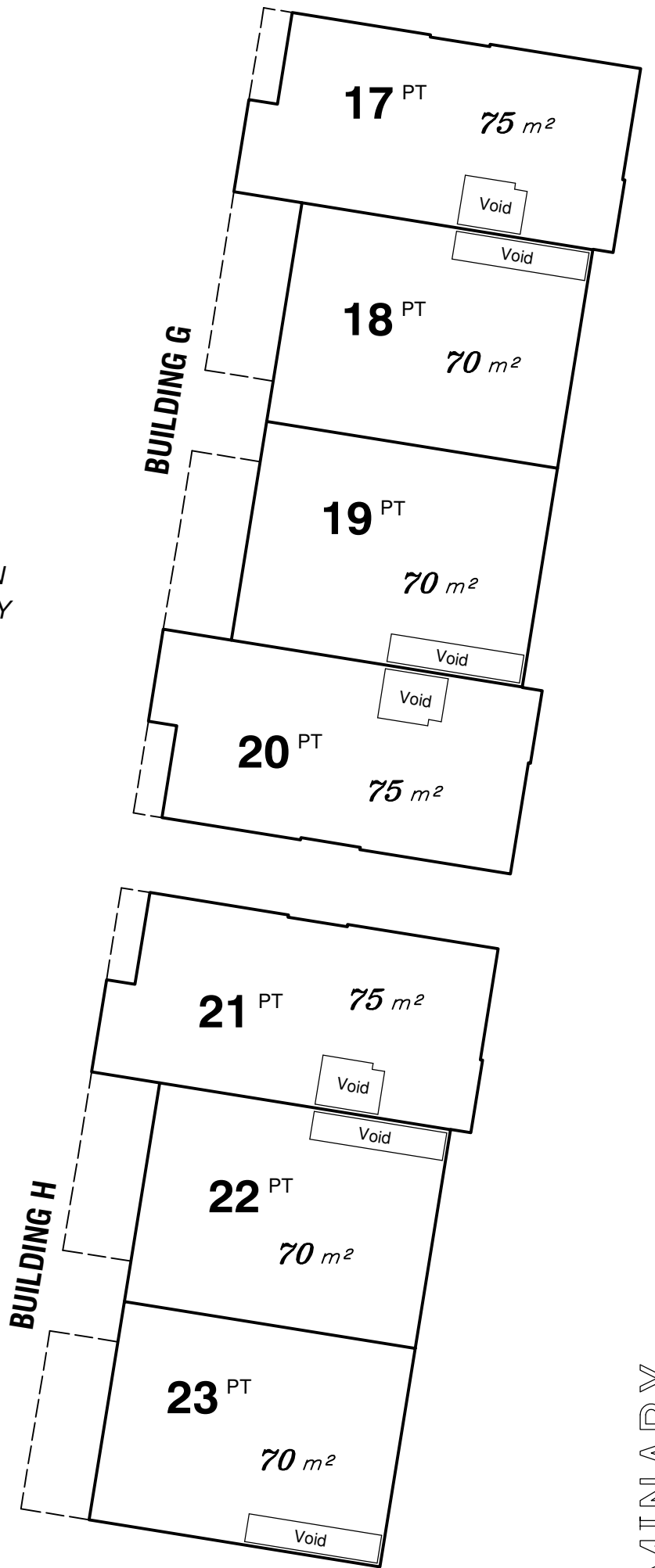

LEVEL B
SCALE 1:200

--- Denotes Outline of Level Below

PRELIMINARY

Scale 1:200 - Lengths are in Metres.

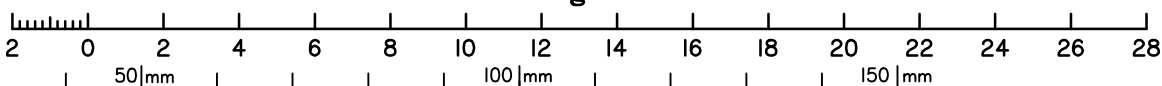

State copyright reserved.

Insert Plan Number **SP321895**

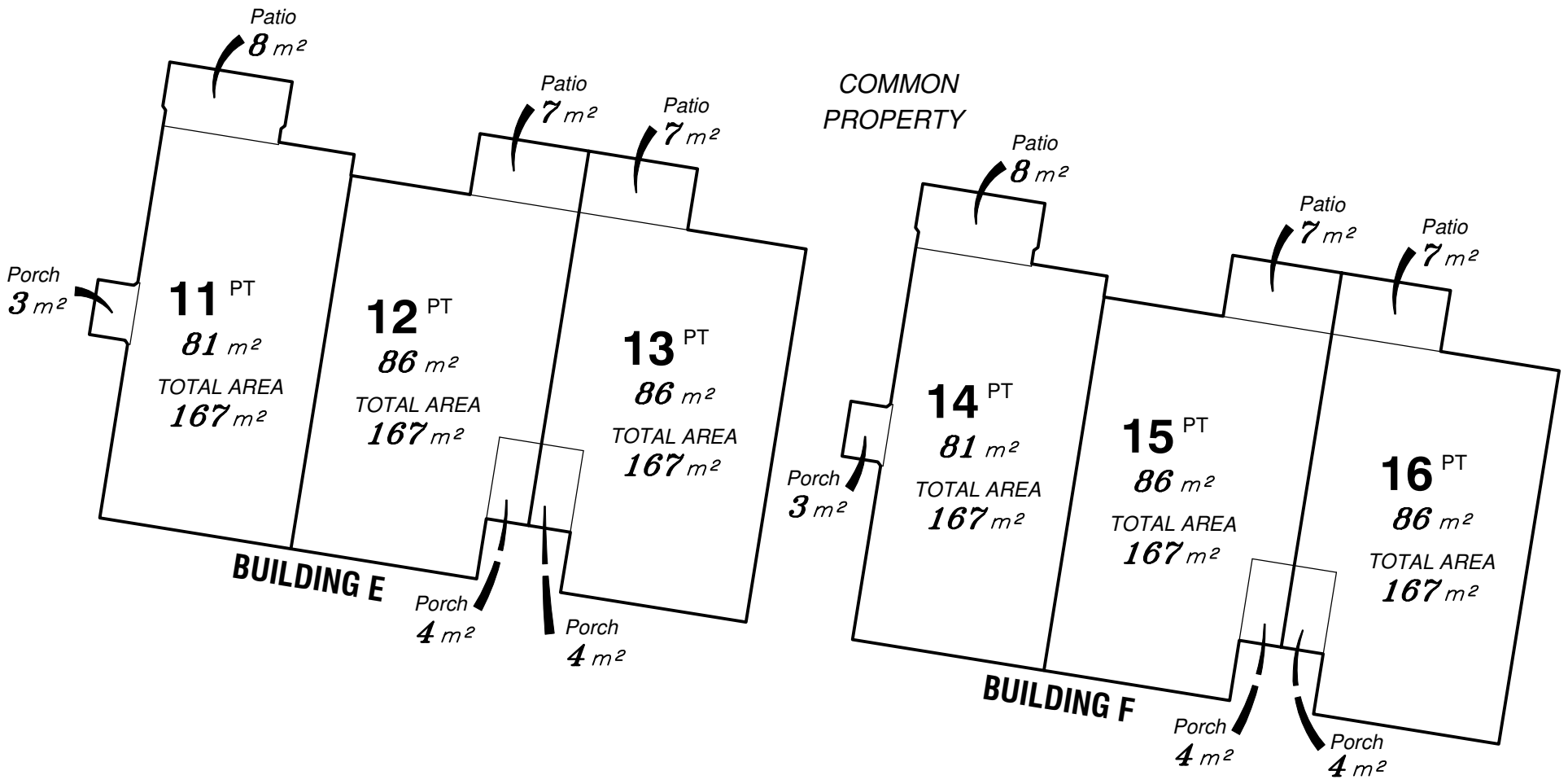

LEVEL A
SCALE 1:200

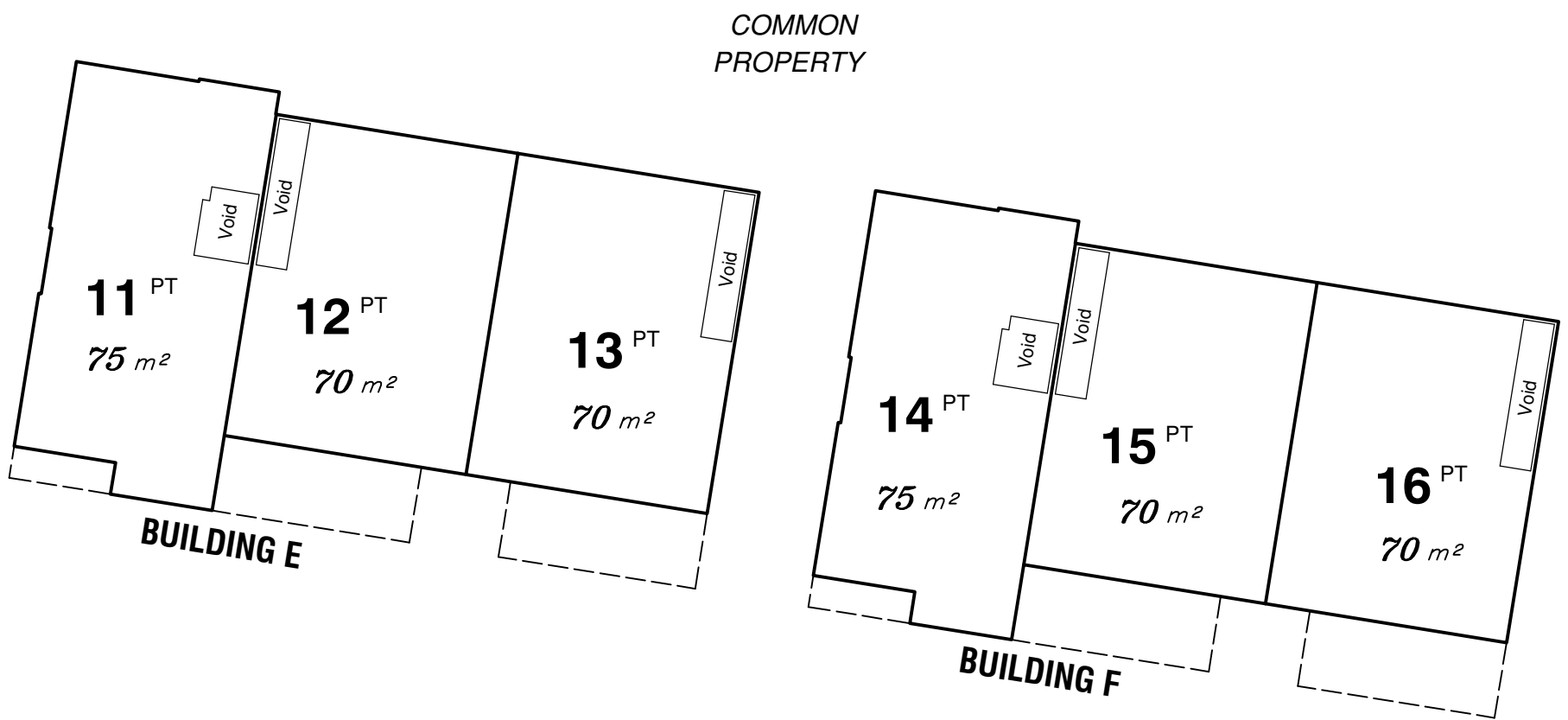

PRELIMINARY

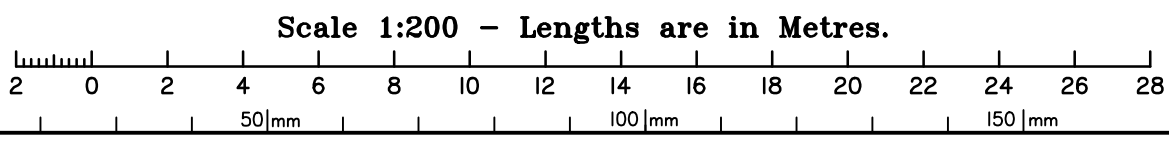

Schedule 4 – Administration Agreement

1. INTRODUCTION

- (a) This Agreement is written to comply with the Act.
- (b) All words defined in Part 4 of Chapter 1 and Schedule 6 of the Act, where the context permits, have the same meaning in this Agreement.
- (c) In this Agreement, terms in bold in the Reference Schedule have the meanings shown opposite them.
- (d) Unless the context otherwise permits:
 - (i) “Act” means the Body Corporate and Community Management Act 1997.
 - (ii) a reference to an item is a reference to an item in the Reference Schedule.
- (e) This Agreement comprises the:
 - (i) Reference Schedule.
 - (ii) Standard Conditions.
 - (iii) any Special Conditions.
- (f) Where there is any inconsistency between any provision added to this Agreement and the printed provisions, the added provisions prevail.
- (g) The Body Corporate acknowledges having received a copy of the Standard Conditions before entering into this Agreement.

2. WHAT IS THIS AGREEMENT

- (a) This Agreement is an engagement of the Manager as the Body Corporate Manager for the Body Corporate.
- (b) The Manager is engaged by the Body Corporate (as an independent contractor) to supply, including through the exercise of delegated powers, administrative services to the Body Corporate.

3. WHAT IS THE TERM OF THIS ENGAGEMENT

- (a) This engagement is for the Term.
- (b) This engagement will be extended by the Body Corporate for one year from the end date stated in Item C, unless the Body Corporate decides at a general meeting before that date not to extend this Agreement.

- (c) However, this engagement (after allowing for renewals under clause 3(b)) must not run for more than three years from the beginning date stated in Item C.

4. WHAT ARE THE FUNCTIONS OF THE MANAGER UNDER THIS AGREEMENT

- (a) The Manager must supply the Agreed Services to the Body Corporate.
- (b) The Manager may supply the Additional Services to the Body Corporate at the Body Corporate’s request.
- (c) The Manager has the custody of and use of the common seal of the Body Corporate.
- (d) The Manager has the authority to sign notices on behalf of the Secretary of the Body Corporate and by-law contravention notices on behalf of the Body Corporate.

5. WHAT ARE THE AUTHORISED POWERS OF THE MANAGER

- (a) The Body Corporate authorises to the Manager all of the powers of the Executive and Ordinary Members of the Committee of the Body Corporate to the full extent permitted by the Act.
- (b) However, the Manager must only use these powers when the Manager determines that the power is of a routine, administrative nature or there are circumstances, particularly in respect of urgent works necessary to ensure the health and safety of building occupants or the preservation of the asset, which dictate the Manager must use the authorised power.
- (c) To avoid doubt, the authorisation does not make the Manager responsible for performing the functions the Body Corporate or the Committee are required to perform under the Act, nor does the authorisation relieve the Body Corporate or the Committee of these functions.
- (d) The authorisation powers do not extend to the Manager being required to obtain a second quote for providing Body Corporate Management services to the Body Corporate.

6. HOW IS THE MANAGER TO BE PAID

- (a) The Body Corporate must pay the Manager the fee for Agreed Services as set out in the attached Schedule.

- (b) The Body Corporate must pay the Manager the fee for Additional Services as set out in the attached Schedule.
- (c) The fee for Agreed Services and the Schedule of Additional Fees and Disbursements increases at the end of each year of this Agreement by the percentage increase.
- (d) The Manager is entitled to:
 - (i) charge the Body Corporate for Disbursements at the rate charged from time to time by the Manager, and which may include a margin above cost to the Manager.
 - (ii) keep fees paid to it for information which the Manager must supply about the Body Corporate under the Act.
 - (iii) keep fees paid to it for the services supplied at the request of Lot owners (eg. information to enable a Lot owner to prepare a REIQ Disclosure Statement).
 - (iv) retain commissions paid to it by the providers of goods and services to the Body Corporate as disclosed in Item K.

7. HOW DO WE GIVE INSTRUCTIONS TO THE MANAGER

- (a) The Committee must nominate a person to provide instructions to the Manager on behalf of the Body Corporate.
- (b) However, if the Committee does not do this, the Chairperson is taken to be nominated to give instructions to the Manager on behalf of the Body Corporate.

8. WHAT ARRANGEMENTS OR RELATIONSHIPS DOES THE MANAGER HAVE WITH OTHER PROVIDERS OF GOODS AND SERVICES TO THE BODY CORPORATE

- (a) The Manager proposes to have the Body Corporate enter into contracts with providers of insurance services.
- (b) The details of these relationships are disclosed in Item J. The commission entitlements are disclosed in Item K.
- (c) The Body Corporate acknowledges that it made its decision to enter into this engagement, and into the contracts with the providers of insurance services, after having been given this engagement in writing disclosing the relationship with the Manager and the commission payable to the Manager.

9. RELEASE & INDEMNITY BY THE BODY CORPORATE

With regard to any act or omission of the Body Corporate that did not result from the direct action or negligence of the Manager; the Body Corporate:

- (a) Releases, discharges and holds harmless the Manager (to the extent permitted by law) from any damages, losses, liabilities, costs, expenses and/or claims arising from or in connection with this act or omission.
- (b) Indemnifies and keeps indemnified the Manager against any damages, losses, liabilities, costs, expenses or claims incurred by the Manager arising from or in connection with this act or omission.

10. WHAT ARE THE RULES FOR TRANSFER OF THIS ENGAGEMENT

- (a) This engagement may be transferred by the Body Corporate if the Body Corporate approves the transfer.
- (b) To avoid any doubt, the approval may be given by the Committee.
- (c) In deciding whether to approve a proposed transfer, the Body Corporate may have regard to:
 - (i) the character of the proposed transferee and related persons of the transferee.
 - (ii) the financial standing of the proposed transferee.
 - (iii) the proposed terms of the transfer.
 - (iv) the competence, qualifications and experience of the proposed transferee, and any related persons of the proposed transferee, and the extent to which the transferee, and any related persons, have received or are likely to receive training; and
 - (v) matters to which, under this engagement, the Body Corporate may have regard.
- (d) The Body Corporate must decide whether to approve a proposed transfer within thirty days after it receives the information reasonably necessary to decide the application for approval.
- (e) The approval may be given on the condition that the transferee enters into a Deed of Covenant to comply with the terms of this engagement.
- (f) The Body Corporate must not:
 - (i) unreasonably withhold approval to the transfer.
 - (ii) require or receive a fee or other consideration for approving the transfer (other than reimbursement for legal expenses reasonably incurred by the Body Corporate in relation to the application for its approval).
- (g) “related persons” of a proposed transferee means:

- (i) if the proposed transferee is a corporation, the corporation's directors, substantial shareholders and principal staff.
- (ii) if a proposed transferee is in partnership - the partners and principal staff of the partnership

11. WHAT ARE THE RULES FOR TERMINATING THIS ENGAGEMENT

- (a) This engagement terminates when it ends or when the Body Corporate gives notice of termination under this Agreement.
- (b) The Body Corporate may terminate this engagement if the Manager (including if the Manager is a Corporation or a Director of the Corporation):
 - (i) is convicted (whether or not a conviction is recorded) of an indictable offence involving fraud or dishonesty.
 - (ii) is convicted (whether or not a conviction is recorded) on indictment of an assault or an offence involving an assault.
 - (iii) engages in misconduct, or is grossly negligent, in carrying out, or failing to carry out functions required under this engagement.
 - (iv) does not carry out duties under this engagement, and persists in not carrying out duties for 14 days or more after the Body Corporate, by written notice, requires the Manager to carry out the duties.
 - (v) carries on a business involving the supply of services to the Body Corporate, or to owners or occupiers of Lots, and the carrying on of the business contrary to law.
 - (vi) transfers an interest in this engagement without the Body Corporate's approval.
 - (vii) fails to disclose to the Body Corporate that it is associated with the providers of repair and maintenance services or the providers of insurance services.
 - (viii) fails to disclose to the Body Corporate that it is entitled to receive a commission from the providers of repair and maintenance services or the providers of insurance services.
- (c) The Manager may terminate this Agreement by giving written notice to the Body Corporate if:
 - (i) the Body Corporate fails to pay the Manager in accordance with this engagement.
 - (ii) the Body Corporate acts, or fails to act, in a way which prevents the Manager from properly performing its functions under this engagement or complying with the Act.
- (d) If this engagement is terminated, the Manager must deliver the records of the Body Corporate to the nominee stated in clause 7 within thirty days of the termination.

12. GOODS AND SERVICES TAX

For the purposes of this clause, a Goods and Services Tax means any tax imposed by any government or regulatory authority which is a tax on goods and services, a tax on consumption, a value-added tax or any similar impost. If the payment of any money under this engagement ever attracts a Goods and Services Tax, then the party making the payment of the money must, in addition, pay the required amount of Goods and Services Tax on the payment.

13. SPECIAL CONDITIONS

Any Special Conditions to the Standard Conditions are stated in Item L.

- A.** This Agreement is made on 2020 at the Annual General Meeting
- OR**
- at an alternate date, on this day of 2020 (*insert date*)
- B. BETWEEN** Body Corporate for **PARKINSON RESIDENCES CTS TBA**
200 Nottingham Road, Parkinson
- AND
- QBS Strata Management Pty Ltd ATF
SE Qld Corporate Management Trust
- C. TERM** **Three Years**
[Clause 3(a)] commencing on
and ending on
- D. FEES** The fee for Agreed Services shall be
[Clause 6(a)] \$4,060.00 plus GST per annum,
payable quarterly in advance.
- E. ADDITIONAL FEES** See attached Schedule
- | | |
|---------------------------------------|-------------------|
| Body Corporate Managers | \$176.00 per hour |
| Clerical | \$ 71.50 per hour |
| Extraordinary General Meetings | \$176.00 per hour |
| Additional Committee Meetings | \$176.00 per hour |
- F. PERCENTAGE INCREASE**
[Clause 6(c)] Increase at the end of each year of engagement:
the greater of CPI or 4%.
- G. DISBURSEMENTS** Payable quarterly in advance - see attached Schedule.
[Clause 6(d)(i)]
- H. AGREED SERVICES** **Secretarial**
[Clause 4(a)] * Convene and attend the Annual General Meeting (up to two hours).
* Convene and attend one Committee Meeting (up to two hours).
* Call nominations for the position of Executive and Ordinary Members
of the Committee.
* Prepare and distribute Meeting Notices.
* Record and distribute Minutes.
* Answer all communications and correspondence
- Financial**
- * Open, maintain and operate a bank account for the Administration and Sinking Funds.
 - * Prepare a Statement of Accounts for each financial year.
 - * Prepare draft Budgets and facilitate Budget Meeting.

- * Issue levy and other contribution notices.
- * Receipt and bank levies daily.
- * Reconcile bank account monthly.
- * Process and pay accounts promptly.
- * Prepare quarterly accounts for Committee upon request.
- * The Manager is authorised to appoint a Tax Agent on behalf of the Body Corporate.

Administrative

- * Establish and maintain the roll and registers.
- * Maintain and keep records.
- * Implement the decisions of the Body Corporate and its Committee.
- * Make available the records for inspection.

Insurance

The Body Corporate instructs the Manager to obtain quotations through a recognised Broker each year for the Body Corporate Insurance, and to renew the policy unless instructed to the contrary by the Body Corporate.

Body Corporate Inspection Information and Certificates

- * Make available the records for inspection.
- * The Body Corporate shall pay to the Manager an amount equivalent to any amount received by the Body Corporate for inspection and the provision of Certificates and other information from Body Corporate Records.

I. ADDITIONAL SERVICES

[Clause 4(b)]

- * Any agreed Service to be undertaken outside of normal business hours.
- * Obtaining quotations for repairs and maintenance:
 - For work under \$1,000.00 - \$50.00 charge.
 - For work above \$1,000.00 - \$80.00 charge.
- * Any reasonable requests by the Body Corporate, not stated as an Agreed Service.
- * Dispute Resolution – Assisting to resolve disputes between owners, resident Managers or contractors, including applications, submissions and attendance with Body Corporate advisers and judiciary.
- * Preparation and lodgment of returns through a registered Tax Agent as may be required by the Australian Taxation Office.
- * Preparing supporting data to facilitate year end audits.
- * Issuing and processing of electricity and other utility invoices.
- * Levy recovery actions as may be required.
- * Obtaining quotations and arranging Sinking Fund Forecasts, Insurance Valuations, Workplace Health and Safety inspections and other inspections required under legislation.
- * Assistance with assignments of management rights.
- * Preparation of Annual General Meeting Notices in excess of 15 Motions.

J. DISCLOSURE OF ASSOCIATES

[Clause 8(b)]

Providers that are associates of the Manager and the nature of the relationship.

Name of Company

Body Corporate Brokers
 Direct Insurance Brokers
 Centrepoint Insurance Brokers
 Regional Insurance Brokers
 PSC Coastwide Insurance Brokers
 Jardine Lloyd Thompson
 Thiel Partners (Tax Agent)

Relationship

QBS Strata Management as referrer
 QBS Strata Management as referrer
 QBS Strata Management as referrer
 QBS Strata Management as referrer
 QBS Strata Management as referrer
 QBS Strata Management as referrer
 QBS Strata Management as referrer

K. DISCLOSURE OF COMMISSIONS

[Clause 8(c)]

Providers that pay a commission to the Manager and the details of the commission.

Name of Company

Body Corporate Brokers
 Direct Insurance Brokers
 Centrepoint Insurance Brokers

Commission Details

0 - 15% base premium
 0 - 15% base premium
 0 - 15% base premium

| | |
|--|-----------------------|
| Regional Insurance Brokers | 0 – 15% base premium |
| PSC Coastwide Insurance Brokers | 0 – 15% base premium |
| Jardine Lloyd Thompson | 30% of broker's fee |
| Thiel Partners Accountants (Tax Agent) | 70% of tax agents fee |

(Agency Agreements other than those specified above may be entered into with other companies after the signing of this Agreement. Any such Agency will be disclosed prior to renewal if this is the case).

L. SPECIAL CONDITIONS
[Clause 13]

The Manager does not accept responsibility or liability for maintenance of the Body Corporate Common area.

**The COMMON SEAL of the Body Corporate
for PARKINSON RESIDENCES
Community Titles Scheme TBA
was affixed on the day of 2020
pursuant to a resolution of the Body Corporate
in the presence of:**

Chairperson

Committee Member

**Signed for and on behalf of
QBS Strata Management Pty Ltd
ABN 86 965 584 736 ATF
SE Qld Corporate Management Trust
on the day of 2020
by authority of a Resolution of the Board
of Directors :**

Director

Director

SCHEDULE OF ADDITIONAL FEES AND DISBURSEMENTS – PARKINSON RESIDENCES CTS TBA

| Item | Cost inclusive of GST |
|--|--|
| Communications and Related Disbursements - Agreed Services | Fixed at \$71.50 per Lot PA |
| Printing, Postage & Stationery - Additional Services Letterhead/Follower Envelopes - Large (C4) - DL Ballot Envelopes Dividers Plastic Sleeves Photocopy Laser Prints All other Printing, Postage and Stationery Levy Notices Microencoded Forms (including cheques) Postage | 22 cents 77 cents 11 cents 55 cents 33 cents 22 cents 33 cents 11 cents At cost 38.5 cents 55 cents At cost |
| Telephone Telephone (local, national, mobile, international), Fax and Email | .85 cents per Lot per month |
| E Commerce Electronic Processing | \$14.85 per Lot PA |
| Financial Reporting Preparation of Information for Audit Preparation of Information for BAS Returns Preparation of Information for Income Tax Returns | \$470.00 \$275.00 per Return \$275.00 |
| Special Levies Set up & On-charging to Lot Owners Special Levies Set Up (2 – 5 lots) Special Levies Set Up (6 lots & over) | \$25 each set up \$5.50 per lot Maximum \$165.00 |
| Billing of Utilities to Lot Owners | \$9.90 per invoice |
| Miscellaneous Insurance Claims Processing Lodgment of Documents with DNR ABN and TFN Registration GST Registration Debt Collection (recovered from owner) <ul style="list-style-type: none"> • First Statement Reminder • Arrears Notice • Instructing Collections Agents (being collection of information, issuing of instructions and follow up) • Monthly monitoring Travelling Expense to Attend Onsite Meetings Dishonoured Cheque Fee Archiving Minute Book Common Seal | \$66.00 per claim under \$1,000.00 \$132.00 per claim between \$1,000.00 and \$4,000.00 \$176.00 all other claims \$110.00 \$110.00 \$110.00 Nil \$33.00 \$88.00 \$11.00 ATO Rate \$33.00 \$5.20 per Lot PA \$25.00 \$44.00 |
| Flying Minute | \$165.00 plus outlays |

Schedule 5 – Caretaking Agreement

BODY CORPORATE FOR PARKINSON RESIDENCES COMMUNITY
TITLES SCHEME

("BODY CORPORATE")

#####

("CARETAKER")

CARETAKER'S AGREEMENT

david k lawyers
lvl 12 300 queen st
brisbane qld 4000
australia

Tel: 07 3102 2583 Fax: 07 3839 3006

CARETAKER'S AGREEMENT
PARKINSON RESIDENCES COMMUNITY TITLES SCHEME

This Agreement is made the _____ day of _____ 20 .

BETWEEN: The Body Corporate for Parkinson Residences Community Titles Scheme
c/- QBS Strata Management, Level 3, 3 Southward, Upper Coomera in the
State of Queensland

("Body Corporate")

AND: _____ of _____

("Caretaker")

INTRODUCTION:

- A The Body Corporate wishes to provide for the better administration, control and management of the Complex and the better maintenance, caretaking and repair of the Common Property.
- B The Caretaker is appointed to perform the Caretaking Duties.
- C The Parties wish to record the terms of their agreement on the following terms.

IT IS AGREED:

1. DEFINITIONS

1.1 Unless the context otherwise requires:

"Act" means the *Body Corporate and Community Management Act 1997 (Qld)*.

"Agreement" means this agreement and all its schedules.

"Associated Party" means:

- (a) in the case of a corporation, a director, secretary or shareholder of that corporation;
- (b) in the case of an individual, a corporation in which the individual is a director, secretary, or shareholder; and
- (c) in the case of a partnership, the partners and management staff of the partnership.

"Body Corporate" means the Body Corporate for the Scheme.

"Body Corporate Assets" means the Body Corporate assets for the Scheme.

"Building" means any of the buildings located on the Scheme Land.

"Caretaker's Lot" means the Lot (if any) in the Scheme of which the Caretaker or an Associated Party is the registered owner.

"Caretaking Duties" means those duties that the Caretaker must perform under this Agreement.

"Commencement Date" means the *[insert fixed date which will be settlement]*

"The Committee" means the Committee of the Body Corporate.

"Common Property" means the Common Property of the Scheme.

"Complex" means the Lots and Common Property comprised in the Scheme.

"CPI" means the Consumer Price Index All Groups for Brisbane published by the Australian Bureau of Statistics, or if that is suspended or discontinued, then a similar figure reasonably determined by the Body Corporate.

"Further Term" means fifteen (15) years commencing on the day immediately after the end of the Term.

"Letting Agent" means the Letting Agent appointed by the Body Corporate for the Scheme (if any).

"Letting Agreement" means a letting agreement entered into by the Body Corporate with the Letting Agent.

"Lots" means lots in the Scheme.

"Maximum Expenditure" means \$1,000.00 or such greater amount as approved by the Committee from time to time.

"Nominee" means the person nominated by the Body Corporate.

"Occupation Authority Plan" means the plan attached as Annexure "A" (if any).

"Owners" means the owners of Lots included in the Scheme and includes mortgagees in possession.

"Plan" means the Survey Plan registered for the Scheme.

"Property" means all land comprised in the Scheme and all improvements erected on the land. Where the context permits the definition extends to all adjoining land over which the Body Corporate has easement rights.

"Related Agreement" means any agreement entered into by the Letting Agent with the Body Corporate for the provision of letting or other services.

"Related Person" means a person or persons who are the directors or shareholders of the Caretaker who in the reasonable opinion of the Body Corporate hold effective control of the Letting Agent.

"Remuneration" means, in the first year of this Agreement, the sum of \$1,000.00 plus GST for each Lot in the Scheme for which a title has been created for the first year of the Term and subject thereafter to any adjustments made in accordance with Clause 4.1 of this Agreement.

"Scheme" means Parkinson Residences Community Titles

Scheme.

"Scheme Land" means the Scheme land identified on the Plan.

"Term" means a period of ten (10) years from the Commencement Date.

INTERPRETATION

2.1 Reference to:

- (a) One gender includes the other genders.
- (b) Singular includes the plural and the plural includes the singular.
- (c) A person includes a body corporate.
- (d) A party includes the parties' executors, administrators, successors and permitted assigns.
- (e) A statute, regulation or provision of a statute or regulation ("Statutory Provision") includes:
 - (i) That Statutory Provision as amended or re-enacted from time to time; and
 - (ii) A statute, regulation or provision enacted in replacement of the Statutory Provision.
- (f) All monetary amounts are in Australian dollars, unless otherwise stated.
- (g) If a party consists of more than one person then this Agreement binds them jointly and each of them separately.
- (h) Headings are for convenience only and do not form part of this Agreement or affect its interpretation.
- (i) A party that is a trustee is bound both personally and in its capacity as a trustee.
- (j) "Including" and similar expressions are not words of limitation.
- (k) Where a word or expression is given a particular meaning, other parts of speech and grammatical forms of that word or expression have a corresponding meaning.
- (l) If an act must be done, or the last day upon which it may be done, falls on a specified day that is not a Business Day, the act must be done instead on the next Business Day.

3. APPOINTMENT AND TERM

3.1 The Body Corporate appoints the Caretaker for the Term to look after the Common Property from the Commencement Date.

3.2 The Caretaker

- (a) accepts the appointment;
- (b) will look after the Common Property as required by this Agreement;
- (c) will ensure that the Common Property is able to be used by the persons entitled and is properly maintained and kept in good repair;
- (d) will perform the Caretaking Duties; and
- (e) is an independent contractor of the Body Corporate.

4. REMUNERATION

- 4.1 The Remuneration will be increased for the second and subsequent years of the Term and the Further Term by the lesser of:
- (a) the same percentage as the last percentage increase in the CPI for one year as last recorded by the Australian Bureau of Statistics immediately before the year in which the Remuneration is to be reviewed; and
 - (b) 3%.
- 4.2 Despite the previous clause the Remuneration for any year will never be less than the Remuneration for the previous year.
- 4.3 The Body Corporate must pay the Remuneration to the Caretaker by equal monthly instalments in arrears, the first payment one calendar month from the Commencement Date and monthly after that.
- 4.4 If the Caretaking Duties under this Agreement are a supply under the *A New Tax System (Goods and Services Tax) Act 1999 (Cth)*, the Body Corporate must pay to the Caretaker in addition to the Remuneration a further amount equal to the GST.
- 4.5 The Remuneration is paid only for the Caretaking Duties and not for any letting or ancillary services which the Caretaker or any other entity provides.
- 4.6 The Caretaker is entitled to a pro rata of the annual remuneration for any Lot/s which are registered part way through any year.

5. CARETAKER'S DUTIES

- 5.1 In addition to any specific duties set out in any schedule to this Agreement, the Caretaker must as reasonably required:
- (a) hose all walkways, access areas and other parts of the Common Property that require hosing;
 - (b) keep clean, tidy and maintained all parts of the Common Property;
 - (c) maintain and clean the swimming pool and recreation areas (if applicable);
 - (d) at the commencement of each day, set out any pool and recreation furniture and equipment;
 - (e) clean any drains and gutters on Common Property;
 - (f) keep clean, tidy and maintained all barbeques as and when required (if applicable);
 - (g) maintain exclusive use areas 800A and 801A and any other areas to which exclusive use is granted to more than one Lot;
 - (h) maintain the gardens and shrubs to a well presented standard, which duty includes watering, fertilising, weeding, mulching and top dressing;
 - (i) keep clean, tidy and maintained the bins for the Scheme and the surrounding Common Property where the bins for the Scheme are located as and when required;
 - (j) effect minor repairs and maintenance to the Common Property where the services of a skilled tradesman are not required.
- 5.2 The Caretaker must arrange and supervise contracts between the Body Corporate and

independent contractors for all work of a specialist nature required for any of those things referred to in the previous clause or for any services to, or work to be carried out to, the Common Property including without limitation:

- (a) specialist repairs and maintenance of the Common Property;
- (b) cleaning of external windows or parts of the Complex not easily accessible by the Caretaker; and
- (c) the provision of water, electricity, gas, fuel, telephone and other necessary services as required by the Body Corporate.

Such contracts with independent contractors will only be entered into with the prior consent of the Body Corporate, but the Body Corporate must not unreasonably withhold such consent.

5.3 The Caretaker must:

- (a) regularly ensure the correct operation and, if necessary, arrange for expert specialist maintenance of:
 - (i) any waste disposal system;
 - (ii) all Common Property electrical apparatus (if applicable);
 - (iii) any pumps and auxiliary motors (if applicable);
 - (iv) any lifts and security systems; and
 - (v) all other parts of the Common Property where inspection and/or maintenance is required;
- (b) arrange all appliances, equipment, materials and supplies necessary to carry out the Caretaking Duties and to generally maintain the Common Property;
- (c) promptly report and account to the Body Corporate for:
 - (i) matters requiring repair or creating a hazard or danger that involves expenditure of money in excess of the Maximum Expenditure;
 - (ii) use by the Caretaker of any Body Corporate funds; and
 - (iii) use by the Caretaker of any other property of the Body Corporate in carrying out the Caretaking Duties;
- (d) monitor compliance with the by-laws of the Body Corporate and advise the Body Corporate of any serious or persistent breaches of them;
- (e) monitor and administer the use of any recreational areas including without limitation any swimming pool, sauna, spa, home heater, gymnasium and workshop;
- (f) keep order and safeguard the Complex against unlawful entry and arrange security contracts at the expense of the relevant Body Corporate as required by the Body Corporate;
- (g) regularly inspect the fire fighting equipment, arrange any requisite inspections by the relevant officer when required and, at the expense of the Body Corporate as relevant, arrange for maintenance necessary to maintain the fire fighting equipment in an efficient working condition;

- (h) maintain and keep open an office as a reception for the caretaking business during the following minimum hours:

Monday – Friday 9.00am -5.00pm; and
Saturday – 9.00am – 12noon

For the avoidance of doubt, if the Caretaker is absent from the office during the above hours while performing its obligations under this Agreement then it will be sufficient compliance with this clause for the Caretaker to be contactable via telephone during that time.

The Caretaker must also be contactable by telephone or mobile phone 24/7 hours in the event of an emergency;

- (i) respond to the Body Corporate and occupants promptly;
- (j) maintain and supervise car parking arrangements on the appropriate areas on the Common Property;
- (k) keep possession of all keys for any Common Property and keys of any owners who provide them to the Caretaker;
- (l) keep the lighting of Common Property operating efficiently;
- (m) issue key cards and pins for access to the building to owners and occupiers and keep a register of key cards and pins as issued for which the Caretaker may charge a reasonable fee for these services;
- (n) to the extent the Caretaker is notified of it, and that occupants are willing to work within the Caretaker's directions, co-ordinate the moving of occupants in and from the Scheme and ensure that when moving occurs the Caretaker shall dedicate the use of a lift (if any) to the occupant and install curtains and other protective measures in the lift (if any) to avoid damage to the lift;
- (o) maintain all Body Corporate Assets;
- (p) keep clean and maintained all footpaths and frontages for the Scheme;
- (q) carry out such other reasonable and appropriate tasks requested by the Body Corporate relevant to the caretaking of the Common Property; and
- (r) if the Caretaker owns the Caretaker's Lot, reside in the Caretaker's Lot or where the Caretaker is a Corporation ensure that the person carrying out the Caretaking Duties resides in the Caretaker's Lot.

5.4 The Caretaking Duties may be carried out by the Caretaker, its delegates or its employees.

5.5 The Caretaking Duties that require work of a specialist nature are limited to the arranging and supervision of all external contracts or agreements.

5.6 Despite any other term of this Agreement or any Community Management Statement, the Caretaker is not required to undertake any duties in relation to the exclusive use areas of any Lot and each Lot owner is responsible for maintaining their exclusive use areas, save that any car parking areas shall be kept clean by the Caretaker where not kept clean by the Lot Owner or occupier.

6. CARETAKER'S CONDUCT

6.1 The Caretaker must:

- (a) have a good working knowledge and understanding of the Act, relevant to the Caretaking Duties;
- (b) act honestly, fairly and professionally in performing the Caretaking Duties;
- (c) exercise reasonable skill, care and diligence in performing the Caretaking Duties;
- (d) act in the best interests of the Body Corporate unless it is unlawful to do so;
- (e) keep the Body Corporate informed of any significant development or issue about an activity performed for the Body Corporate;
- (f) take reasonable steps to ensure an employee of the Caretaker complies with the Act, in performing the Caretaking Duties;
- (g) not engage in fraudulent or misleading conduct in performing the Caretaking Duties;
- (h) not engage in unconscionable conduct in performing the person's functions under the person's engagement;
- (i) intentionally deleted;
- (j) take reasonable steps to ensure goods and services the person obtains for or supplies to the Body Corporate are obtained or supplied at competitive prices.

6.2 If a Body Corporate or its committee requests, in writing, the Caretaker to show that the Caretaker has kept the Body Corporate records as required under this Agreement in relation to the Caretaking Duties, the Caretaker must comply with the request within the reasonable period stated in the request.

7. EXPENSES

7.1 All of the Caretaking Duties must be carried out at the cost and expense of the Caretaker unless this Agreement provides that they are to be carried out at the expense of the Body Corporate.

7.2 The Body Corporate must pay all costs and expenses for:

- (a) all work of a specialist nature;
- (b) all other contracts or agreements with independent contractors;
- (c) all materials and consumables (such as garden fertilisers, pool chemicals, detergents etc) necessary to enable to Caretaker to perform the Caretaking Duties;
- (d) all out-of-pocket costs for repair and maintenance of the Common Property.

7.3 The Caretaker can spend up to the Maximum Expenditure for each individual item of expenditure from monies of the Body Corporate in carrying out the Caretaking Duties.

7.4 The Body Corporate must reimburse the Caretaker for any of the Caretaker's monies spent under the previous clause within 14 days of the Caretaker providing written evidence of the expenditure.

7.5 The Caretaker must pay for all costs and expenses associated with the operation of their office, reception areas and any areas under occupation authority.

8. INSTRUCTIONS

- 8.1 The Body Corporate must:
- (a) nominate one person to communicate with the Caretaker on its behalf; and
 - (b) notify the Caretaker in writing of the appointment of that Nominee or its replacement.
- 8.2 The Caretaker must:
- (a) confer with the Nominee concerning the Caretaking Duties; and
 - (b) attend any general meeting or Committee meeting of the Body Corporate if requested and given reasonable notice by the Nominee.

9. ASSIGNMENT

- 9.1 The Caretaker must not assign its interest in this Agreement unless it obtains the Body Corporate's consent.
- 9.2 The Body Corporate must:
- (a) not unreasonably, arbitrarily or capriciously refuse or delay giving its consent to any proposed assignment; and
 - (b) give its consent or refusal to any proposed assignment within 30 days of the Caretaker giving to it the information reasonably necessary for the Body Corporate to properly consider the proposed assignment.
- 9.3 Before giving its consent to any proposed assignment, the Body Corporate will be entitled to require:
- (a) satisfactory evidence that the proposed assignee and any Associates are financially sound and reputable, responsible, respectable and capable of satisfactorily performing the Caretaking Duties; and
 - (b) two business references, two personal references and a bank reference of the proposed assignee and any Associates.
- 9.4 As a condition of giving its consent to any assignment, the Body Corporate will be entitled to require:
- (a) that the proposed assignee execute in favour of the Body Corporate an Agreement of Covenant to comply with the terms of this Agreement;
 - (b) that the Caretaker pay to the Body Corporate all legal costs incurred by it in giving its consent;
 - (c) if the proposed assignee is a company, other than a public company, personal guarantees from the working directors and principal shareholders; and

- (d) that the assignee, or if it is a company, it or its Controller becomes the registered owner of the Caretaker's Lots and is also the assignee of rights to act as Letting Agent in respect of the Scheme.

9.5 The Body Corporate must not require or receive any premium, payment or benefit for any request to consent or consent given under this clause, except as provided in this clause.

10. TERMINATION

10.1 Each of the following events constitutes a default by the Caretaker:

- (a) the Caretaker breaches an obligation under this Agreement and in the Body Corporate's reasonable opinion:
 - (i) the non-observance can be remedied but the Caretaker does not remedy it within 14 days after receiving written notice from the Body Corporate requiring rectification;
 - (ii) the non-observance is substantial and can not be remedied or compensated for; or
 - (iii) the non-observance cannot be remedied but the Body Corporate can be compensated and the Caretaker does not pay the Body Corporate compensation for the breach within 30 days after the Body Corporate gives it a notice to pay;
- (b) it becomes insolvent or is subject to a form of external administration under the Corporations Law or is subject to a sequestration order provided that if a Financier (as defined by the Body Corporate and Community Management Act 1997) or a Controller (as defined in the Corporations Act 2001) is appointed by a Financier to the Caretaker in respect of this Caretaking Agreement, the rights of the Body Corporate to terminate this Caretaking Agreement under this clause do not apply;
- (c) it persistently and repeatedly breaches this Agreement materially or substantially (which shall mean at least 5 times in any one year of the Term) despite the fact that individual breaches may from time to time be remedied;
- (d) it engages in misconduct or is grossly negligent in carrying out or failing to carry out obligations under this agreement;
- (e) if the Caretaker is an individual and it is convicted upon indictment of any criminal charge;
- (f) if the Caretaker sells or transfers its interest in the Manager's Unit without at the same time selling or assigning its interest in this Agreement as required by this Agreement;
- (g) a Related Agreement is terminated;

10.2 If the Caretaker makes default at any time the Body Corporate may at its election by notice in writing at any time terminate this Agreement. Termination of this Agreement is without prejudice of the rights of the Body Corporate in respect of the default by the Caretaker.

10.3 If the Body Corporate fails to perform or observe any of its obligations and duties under this Agreement within 60 days after written notice from the Caretaker

specifying the failure and requiring its rectification, the Caretaker may by written notice terminate this Agreement.

11. AUTOMATIC TERMINATION OF CARETAKING AGREEMENT FOR SUBSIDIARY SCHEME

Intentionally deleted.

12. CARETAKER'S LOT

- 12.1 The Caretaker may, or if it is a company it or its Controller may own or otherwise have the right to occupy the Caretaker's Lot.
- 12.2 If, under Clause 12.1, the registered owner of the Caretaker's Lots is some person or persons other than the Caretaker, the Caretaker must if requested by the Body Corporate procure such person or persons to enter into a Deed of Covenant with the Body Corporate (to be prepared by the Body Corporate at the expense of the Caretaker) to be bound by the terms of this Agreement as far as they relate to the Caretaker's Lot.
- 12.3 If the Body Corporate gives its consent under this Agreement to an assignment of the Caretaker's interest in this Agreement, the Caretaker or the owner of the Caretaker's Lot will be required to sell the Caretaker's Lot so that upon such assignment and sale, there will be compliance with this clause.
- 12.4 Upon the expiry or sooner termination of this Agreement, the Caretaker will cause the sale of the Caretaker's Lot to the party to whom the Body Corporate enters into an agreement on terms similar to those contained in this Agreement.
- 12.5 The purchase price of the Caretaker's Lot under this clause will be as agreed, or failing agreement as determined by a registered valuer nominated by the President of the Australian Institute of Valuers and Land Economists (Queensland Chapter). The valuer's costs will be paid by the Body Corporate except in the case of termination of this Agreement as a result of a breach by the Caretaker, in which case the valuer's costs will be paid by the Caretaker.
- 12.6 The terms and conditions of a sale referred to under this clause will be those contained in the standard REIQ Contract applicable to the sale of community title lots current at the time of such sale, and will provide for a 5% deposit and completion 30 days after the date of the Contract.

13. LETTING BUSINESS

- 13.1 If the Caretaker or an Associated Party has entered into a Letting Agreement with the Body Corporate contemporaneously with entering into this Agreement, the parties acknowledge and agree that:
 - (a) a default under the Letting Agreement will constitute a default under this Agreement, and vice versa;
 - (b) upon the expiration or termination of the Letting Agreement, this Agreement will expire or terminate on the same date; and
 - (c) the Body Corporate need not give its consent to an assignment of this Agreement unless the Caretaker assigns to the proposed assignee at the same time its interest in the Letting Agreement.

14. FURTHER TERM

14.1 If there is not, at the time the Caretaker gives notice under this clause nor at the end of the Term, an outstanding breach of this Agreement by the Caretaker entitling the Body Corporate to terminate it, the Caretaker may by giving written notice to the Body Corporate not later than three calendar months nor earlier than six calendar months prior to the expiration of the Term, extend or renew this Agreement for the Further Term, otherwise upon the same conditions as are contained in this Agreement with the exception of this clause 14 which will be deleted.

14.2 No option may be exercised unless the option in a Related Agreement is exercised.

15. OCCUPATION AUTHORITY

15.1 The Body Corporate grants the Caretaker the exclusive right to use and occupy the area identified on the Occupation Authority Plan to assist the Caretaker in performing its duties under this Agreement.

15.2 The Caretaker must keep the Occupation Authority areas in a clean and tidy condition.

16. COMPLIANCE

16.1 The Parties agree to comply with the provisions of all statutes regulating or related to this Agreement.

17. FURTHER ASSURANCES

17.1 Each party must promptly or at its own cost do all things (including executing all documents) necessary or desirable to give full effect to this Agreement.

18. SEVERABILITY

18.1 If anything in this Agreement is unenforceable, illegal or void then it is severed and the rest of this Agreement remains in force.

19. ENTIRE UNDERSTANDING

19.1 This Agreement:

- (a) contains the entire Agreement and understanding between the Parties on everything connected with the subject matter of this Agreement;
- (b) supersedes any prior agreement or understanding or anything connected with that subject matter.

19.2 Each Party has entered into this Agreement without relying on any representation by any other Party or any person purporting to represent that Party.

20. VARIATION

20.1 An amendment or variation to this Agreement is not effective unless it is in writing and signed by the Parties.

21. WAIVER

21.1 A Party's failure or delay to exercise a power or right does not operate as a waiver of that power or right.

- 21.2 The exercise of a power or right does not preclude either its exercise in the further or the exercise of any other power or rights.
- 21.3 A waiver is not effective unless it is in writing.
- 21.4 Waiver of a power or right is effective only in respect of the specific instance to which it relates and for the specific purpose for which it is given.

22. COSTS AND DISBURSEMENTS

- 22.1 Each party must pay its own costs and disbursements connected with the negotiation, preparation and execution of this Agreement.
- 22.2 The Caretaker shall pay all duties associated with this Agreement.

23. NOTICES

- 23.1 A notice or other communication ("Notice") connected with this Agreement has no legal effect unless it is in writing and:
- (a) delivered by hand at the address of the addressee set out in this Agreement or subsequently notified;
 - (b) sent by post, postage pre-paid, to that address; or
 - (c) sent by facsimile to the facsimile number of the addressee.
- 23.2 A Notice is deemed given and received:
- (a) if delivered, upon delivery;
 - (b) if sent by post on the third Business Day (to the address to which it is posted) after posting; or
 - (c) if sent by facsimile before 5.00pm on a Business Day at the place of receipt on the day it is sent or otherwise on the next Business Day at the place of receipt.
- 23.3 Despite the previous clause, a facsimile is not deemed given or received unless at the conclusion of the transmission the sender's facsimile machine issues a transmission report which indicates that relevant facsimile has been sent.

24. GOVERNING LAW AND JURISDICTION

- 24.1 The law of Queensland governs this Agreement.
- 24.2 The parties submit to the non-exclusive jurisdiction of the courts of Queensland and consent to all claims and disputes in relation to this Agreement being instituted in the central Brisbane jurisdiction.

SCHEDULES OF CARETAKERS SPECIFIC DUTIES

1. Cleaning Duties – Specific

To maintain in a clean and tidy condition, using normal commercial practices, those areas of Common Property and elsewhere as nominated, defined at the frequency indicated.

| TASK | ITEM | DETAILS | FREQUENCY |
|-------------|--|---|--------------------|
| 1. | Carpark Areas | Sweep or hose dirt and rubbish. | Weekly |
| | | Replace blown light bulbs | Weekly |
| 2. | Pool Areas (including any wading and plunge pool/s) (if any) | Clean pool surrounds and keep orderly. Test and record ph levels and treat pools as required. Maintain consumable supplies. | Daily |
| 4. | Communal recreation (BBQ, sauna and store/plant room) (if any) | Clean and remove rubbish and maintain consumable supplies. | Daily |
| 5. | Toilets (if any) | Clean, remove rubbish and maintain consumable supplies | Twice Daily |
| 6. | Footpaths | Sweep and clean, remove rubbish | Daily as required. |
| 7. | Driveways | Sweep and clean, remove rubbish | Daily as required. |

2. Gardening Duties – specific

To maintain all common area gardens and facilities to a satisfactory commercial standard at the frequency indicated.

| TASK | ITEMS | DETAILS | FREQUENCY |
|-------------|---------------------------|--|---|
| 1. | Gardens – common property | Ensure any watering system maintained in good working order and make necessary adjustments to timer to comply with rostered watering days. | Weekly |
| | | Remove all weeds | Weekly |
| | | Trim or prune plants, replace as necessary | As required |
| | | Fertilise | Quarterly |
| 2. | Lawns- common property | Mow and edge | Weekly or when reasonably required in cooler months |

Executed as an Agreement the _____ day of

20 .

The Common Seal of Parkinson Residences
Community Titles Scheme was affixed this
day of 20]

in the presence of:]

A witness

Full name of witness

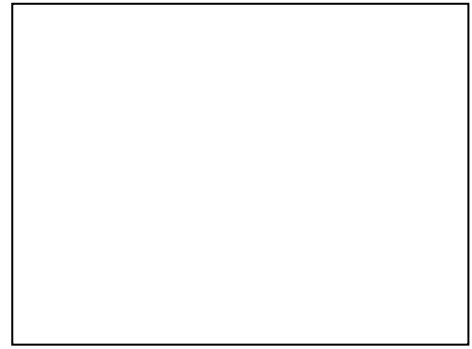

Chairman

Secretary

Signed Sealed and delivered by]
the Caretaker]
the _____ day of 20]
in the presence of]

A witness

Full name of witness



ANNEXURE A
OCCUPATION AUTHORITY PLAN

Schedule 6 – Community Management Statement

THIS STATEMENT MUST BE LODGED TOGETHER WITH A FORM 14 GENERAL REQUEST AND IN THE CASE OF A NEW STATEMENT MUST BE LODGED WITHIN THREE (3) MONTHS OF THE DATE OF CONSENT BY THE BODY CORPORATE

Office use only
CMS LABEL NUMBER

This statement incorporates and must include the following:

- Schedule A - Schedule of lot entitlements*
- Schedule B - Explanation of development of scheme land*
- Schedule C - By-laws*
- Schedule D - Any other details*
- Schedule E - Allocation of exclusive use areas*

1. Name of community titles scheme
Parkinson Residences Community Titles Scheme

2. Regulation module
Accommodation Module

3. Name of body corporate
Body Corporate for Parkinson Residences Community Titles Scheme

| 4. Scheme land | Title Reference |
|---|-----------------|
| Lot on Plan Description | |
| Lots 1 – 29 on SP 321895 | title to issue |
| Common Property of Parkinson Residences CTS | title to issue |

5. #Name and address of original owner
Highway Developments No.1 Pty Ltd A.B.N. 42 625 791 844
301-302/ 50 Marine Parade
Southport QLD 4215

6. Reference to plan lodged with this statement
SP 321895

first community management statement only

7. Local Government community management statement notation

.....signed

.....name and designation

.....name of Local Government

8. Execution by original owner/Consent of body corporate

Highway Developments No.1 Pty Ltd A.B.N. 42 625 791 844 by its duly constituted Attorney [] under registered Power of Attorney No. [] who declares that he has no knowledge of the revocation of the Power of Attorney

/ /
Execution Date

.....
***Execution**

*Original owner to execute for a first community management statement
*Body corporate to execute for a new community management statement

Privacy Statement

Collection of this information is authorised by the Body Corporate and Community Management Act 1997 and is used to maintain the publicly searchable registers in the land registry. For more information about privacy in NR&W see <http://www.nrw.qld.gov.au/about/privacy/index.html>.

| | |
|-------------------|-------------------------------------|
| SCHEDULE A | SCHEDULE OF LOT ENTITLEMENTS |
|-------------------|-------------------------------------|

| Lot on Plan | Contribution | Interest |
|---------------------|--------------|----------|
| Lot 1 on SP 321895 | 1 | 1 |
| Lot 2 on SP 321895 | 1 | 1 |
| Lot 3 on SP 321895 | 1 | 1 |
| Lot 4 on SP 321895 | 1 | 1 |
| Lot 5 on SP 321895 | 1 | 1 |
| Lot 6 on SP 321895 | 1 | 1 |
| Lot 7 on SP 321895 | 1 | 1 |
| Lot 8 on SP 321895 | 1 | 1 |
| Lot 9 on SP 321895 | 1 | 1 |
| Lot 10 on SP 321895 | 1 | 1 |
| Lot 11 on SP 321895 | 1 | 1 |
| Lot 12 on SP 321895 | 1 | 1 |
| Lot 13 on SP 321895 | 1 | 1 |
| Lot 14 on SP 321895 | 1 | 1 |
| Lot 15 on SP 321895 | 1 | 1 |
| Lot 16 on SP 321895 | 1 | 1 |
| Lot 17 on SP 321895 | 1 | 1 |
| Lot 18 on SP 321895 | 1 | 1 |
| Lot 19 on SP 321895 | 1 | 1 |
| Lot 20 on SP 321895 | 1 | 1 |
| Lot 21 on SP 321895 | 1 | 1 |
| Lot 22 on SP 321895 | 1 | 1 |
| Lot 23 on SP 321895 | 1 | 1 |
| Lot 24 on SP 321895 | 1 | 1 |
| Lot 25 on SP 321895 | 1 | 1 |
| Lot 26 on SP 321895 | 1 | 1 |
| Lot 27 on SP 321895 | 1 | 1 |
| Lot 28 on SP 321895 | 1 | 1 |
| Lot 29 on SP 321895 | 1 | 1 |
| TOTALS | 29 | 29 |

CALCULATION OF CONTRIBUTION SCHEDULE OF LOT ENTITLEMENTS

The contribution schedule lot entitlements for the scheme have been decided in accordance with the equality principle under s46(7) of the *Body Corporate and Community Management Act 1997*

The contribution schedule lot entitlements for all the lots in the scheme are equal.

CALCULATION OF THE INTEREST SCHEDULE LOT ENTITLEMENTS

The interest schedule lot entitlements reflect the market values of the lots in the scheme.

| | |
|-------------------|--|
| SCHEDULE B | EXPLANATION OF THE DEVELOPMENT OF SCHEME LAND |
|-------------------|--|

Not applicable.

| | |
|-------------------|----------------|
| SCHEDULE C | BY-LAWS |
|-------------------|----------------|

1 NOISE

- 1.1 The Owner or Occupier of a Lot must not create noise likely to interfere with the peaceful enjoyment of a person lawfully on another Lot or the Common Property.

2 VEHICLES AND PARKING

- 2.1 The Owner or Occupier of a Lot must not, without the Body Corporate's written approval:
- (a) park a vehicle, or allow a vehicle to stand, on the Common Property, or
 - (b) permit an invitee to park a vehicle, or allow a vehicle to stand, on the Common Property, except for the designated visitor parking which must remain available at all times for the sole use of visitors' vehicles.
- 2.2 An approval under subsection (1) must state the period for which it is given, with the exception of designated visitor parking. However, the Body Corporate may cancel the approval by giving seven (7) days written notice to the Owner or Occupier, with the exception of designated visitor parking.
- 2.3 Despite any other By-law, designated visitor parking must remain available at all times for the sole use of visitor vehicles.
- 2.4 The Body Corporate has the right to have any vehicle parked contrary to these By-laws towed at the vehicle at the owner's expense.
- 2.5 Visitor parking spaces are to be clearly line-marked "Visitor" or similar to reflect their use.

3 OBSTRUCTION

- 3.1 The Owner or Occupier of a Lot must not obstruct the lawful use of the Common Property by someone else.

4 DAMAGE TO LAWNS ETC

- 4.1 The Owner or Occupier of a Lot must not:
- (a) damage any lawn, garden, tree, shrub, plant or flower on the Common Property; or
 - (b) use a part of the Common Property as a garden without the written approval of the Body Corporate.
- 4.2 An approval under subsection (1) must state the period for which it is given.
- 4.3 However, the Body Corporate may cancel the approval by giving seven (7) days written notice to the Owner or Occupier.

5 DAMAGE TO COMMON PROPERTY

- 5.1 An Owner or Occupier of a Lot must not, without the Body Corporate's written approval, mark, paint, drive nails, screws or other objects into or otherwise damage or deface a structure that forms part of the Common Property
- 5.2 However, an Owner or Occupier may install a locking or safety device to protect the Lot against intruders, or a screen to prevent entry of animals or insects if the device or screen is soundly built and is consistent with the colour, style and materials of the Building.
- 5.3 The Owner or Occupier must keep a device installed under subsection (2) in good order and repair.

6 SECURITY SYSTEMS

- 6.1 The Body Corporate shall be responsible for the maintenance and up-keep of all security systems on Scheme

Land and may make rules in relation to the security system from time to time by way or ordinary resolution in a general meeting.

- 6.2 At no time shall the Body Corporate be responsible to the Owner or Occupier (and they shall not be entitled to make claim for compensation or damages) in the event of a failure of all or any of the security systems on the Scheme Land to operate in the manner in which they were intended.

7 LEAVING OF RUBBISH ETC ON COMMON PROPERTY

- 7.1 The Owner or Occupier of a Lot must not leave rubbish, dirt, dust or other materials on the Common Property in a way or place likely to interfere with the enjoyment of the Common Property by someone else.

8 APPEARANCE OF LOT

- 8.1 The Owner or Occupier of a Lot must not, without the Body Corporate's written approval, make a change to the external appearance of the Lot.
- 8.2 The Owner or Occupier of a Lot must not, without the Body Corporate's written approval:
- (a) hang washing, towel, bedding, clothing or another cloth article if the article is visible from another Lot or the Common Property or from outside the Scheme Land; or
 - (b) display a sign, advertisement, placard, banner, pamphlet or similar article if the article is visible from another Lot or the Common Property or from outside the Scheme Land.

9 STORAGE OF FLAMMABLE MATERIALS

- 9.1 The Owner or Occupier of a Lot must not, without the Body Corporate's written approval, store a flammable substance on the Common Property.
- 9.2 The Owner or Occupier of a Lot must not, without the Body Corporate's written approval, store a flammable substance on the Lot unless the substance is used or for intended for use for domestic purposes.
- 9.3 However, this section does not apply to the storage of fuel in:
- (a) the fuel tank of a vehicle, boat or internal combustion engine; or
 - (b) a tank kept on a vehicle or boat in which the fuel is stored under the requirements of the law regulating the storage of flammable liquid.

10 WASTE MANAGEMENT

- 10.1 The Owner or Occupier acknowledge there is provision for Waste Management for the Scheme in the Development Approval.
- 10.2 The Body Corporate will ensure the Owners and Occupiers comply with the Waste Management requirements in accordance with the Development Approval.
- 10.3 The Owner or Occupier must:
- (a) comply with all local government local laws about disposal of garbage; and
 - (b) ensure that the Owner or Occupier does not, in disposing of garbage, adversely affect the health, hygiene or comfort of the Owners or Occupiers of other Lots.
- 10.4 The Owner or Occupier must comply with all reasonable directions of the Caretaker in relation to the disposal of recyclable garbage.
- 10.5 Unless otherwise approved by Council, all waste collections must take place between 7.00 am and

6.00 pm.

11 KEEPING OF ANIMALS

11.1 Subject to section 181(1) of the Act an Owner or Occupier of a Lot must not, without the Body Corporate's written approval:

- (a) bring or keep an animal on the lot or the Common Property; or
- (b) permit an invitee to bring or keep an animal on the Lot or the Common Property.

11.2 The Owner or Occupier must obtain the Body Corporate's written approval before bringing or permitting an invitee to bring an animal onto the Lot or the Common Property and such approval may be given subject to certain terms and conditions as determined by the Committee from time to time.

12 OBJECTS KEPT ON COMMON PROPERTY

12.1 An Owner or Occupier must not leave any object of any description on the Common Property. In the event that objects are left on the Common Property, any Owner or Occupier shall immediately remove such object.

12.2 The Body Corporate shall have the right to remove and dispose of any item left on the Common Property.

13 USE OF LOTS

13.1 Subject to any exclusions contained in these By-laws an Owner or Occupier of a Lot shall not use that Lot or permit the same to be used otherwise than as a private residence nor for any purpose that may cause a nuisance or hazard or for any illegal or immoral purpose or for any other purpose that may endanger the safety or good reputation of persons residing within the Scheme Land.

13.2 Despite sub-section 1, the Caretaker may occupy a Lot in the Scheme and operate a letting service and general caretaking operations from the designated Lot for Lots in the Scheme.

14 USE OF RADIOS ETC

14.1 An Owner or Occupier of a Lot shall not operate or permit to be operated upon the parcel any radio, two way radio, short wave radio, transmitter, telecommunications device or electronic equipment so as to interfere with any domestic appliance or apparatus (including a radio or television receiver) lawfully in use upon the Common Property or in any other Lot.

15 STRUCTURAL ALTERATIONS TO THE INTERIOR OF LOTS

15.1 The manner and style of any structural fit out or structural alteration to the interior of any Lot must have the prior written approval of the Committee. The Committee shall be entitled to request plans and specifications as it might consider necessary to enable it to grant its approval and the owner of a Lot shall provide all such plans and specifications PROVIDED HOWEVER that where kitchen facilities are to be installed an extraction system approved by the Committee and relevant Statutory Authorities must be installed.

16 ALTERATIONS TO THE EXTERIOR OF LOTS

16.1 Where an Owner proposes to carry out work, which will alter the exterior of any Lot, the Owner shall follow the procedure set out below:

- (a) Apply in writing to the Body Corporate outlining the proposed work and provide plans and specifications. Such plans and specifications must be of the same architectural standard as the Building.
- (b) The Body Corporate on behalf of the Owner shall submit to the architect nominated by the Committee from time to time the plans and specifications for his approval in writing. The Body Corporate will use its best endeavours to ensure that the architect gives a decision promptly.

- (c) The approval of the architect to any plans and specifications shall be considered by the Committee, provided that the architect shall be entitled to approve such plans with appropriate variations. If the architect refuses to give any approval the Owner shall not be entitled to make the alterations proposed.
- (d) If the Architect approves such plans then the proposal will be submitted to a general meeting of the Body Corporate for permission to proceed with alterations.
- (e) Any costs associated with the procedure outlined above, including any fee from the architect, shall be paid by the Owner seeking to make the alteration.
- (f) The Owner must also obtain all necessary approvals from any other relevant authority.

17 BALCONIES, TERRACES, FENCES, PERGOLAS, SCREENS, EXTERNAL BLINDS OR AWNINGS

- 17.1 An Owner or Occupier of a Lot shall not construct or permit the construction of any terrace, fence, pergola, screen, external blind or awning of any kind within or upon a Lot or on Common Property without the prior approval in writing of the Committee and/or approval from any other relevant authority. Such work must be carried out in a workmanlike manner and must not detract from the overall appearance of the Building.
- 17.2 The Owner of a Lot shall be responsible for the maintenance and repair of any fence which forms part of the Lot. The Body Corporate shall have the power to repair or replace such fence at the expense of the Lot Owner should the fence fall into disrepair.
- 17.3 All balconies and terraces shown on the approved drawings and documents, are to remain unenclosed with no shutters, glazing, louvres or similar permanent fixtures other than those consistent with the relevant Brisbane Planning Scheme Codes/Policies and clearly depicted on the approved drawings.

18 ALTERATIONS TO COMMON PROPERTY

- 18.1 No alterations are to be made to the Common Property by the Owner or Occupier of a Lot without the written authority of the Committee.
- 18.2 Any alteration made to Common Property or fixture or fitting attached to Common Property by an Owner or Occupier of a Lot, whether made or attached with or without the approval of the Committee, shall, unless otherwise provided by resolution of general meeting or of a meeting of the Committee, be repaired and maintained by the Owner or Occupier for the time being of the Lot.
- 18.3 The Body Corporate will ensure any graffiti on the Common Property is removed as soon as possible to reduce its reoccurrence.

19 MAINTENANCE OF LOTS

- 19.1 Each Owner shall be responsible for the maintenance of their Lot and shall ensure that their Lot is so kept and maintained as not to be offensive in appearance to other Lot owners through the accumulation of excess rubbish or otherwise. Maintenance of lawns and gardens that are located within the Lot, will be the responsibility of the Lot owner. All such lawns and gardens are to be mown regularly and kept well maintained.

20 REPLACEMENT OF GLASS

- 20.1 Windows shall be kept clean by the Owner or Occupier of a Lot and promptly replaced by the Owner of the Lot with fresh glass of the same kind and weight as originally installed.

21 BEHAVIOUR OF INVITEES

- 21.1 An Owner or Occupier of a Lot shall take all reasonable steps to ensure that their invitees do not behave in a manner likely to interfere with the peaceful enjoyment of the Owner or Occupier of another Lot or of any person lawfully using Common Property.
- 21.2 The Owner or Occupier of a Lot shall be liable to compensate the Body Corporate in respect of all damage to the Common Property or personal property vested in it caused by such Owner or Occupier or their invitees.

- 21.3 An Owner or Occupier of a Lot which is the subject of a lease or licence agreement shall take all reasonable steps, including any action available to him under any such lease or licence agreement, to ensure that any lessee or licensee or other occupier of the Lot or their invitees comply with the provisions of the By-Laws.
- 21.4 The duties and obligations imposed by these By-laws on an Owner or Occupier of a Lot shall be observed not only by the Owner or Occupier but also by the guests, servants, employees, agents, children, invitees and licensees of such Owner or Occupier.
- 21.5 Where the Body Corporate expends money to make good damage caused by a breach of the Act, or of these By- laws by any Owner or Occupier of a Lot or the guests, servants, employees, agents, children, invitees or licensees of the Owner or Occupier of any Lot or any of them, the Committee shall be entitled to recover the amount so expended as a debt in any action in any Court of competent jurisdiction from the Owner or Occupier of the Lot at the time when the breach occurred.
- 21.6 An Owner or Occupier shall require their invitees to be quiet at all times when passing over Common Property after 11.00pm.

22 RECREATION AREAS

- 22.1 All Owners and Occupiers when making use of the Recreation Areas must ensure:
- (a) that their invitees and guests do not use the Recreation Areas or any of them unless they or another Owner or Occupier accompanies them;
 - (b) that children below the age of sixteen (16) years are not in or around the Recreation Areas unless accompanied by an adult Owner or Occupier exercising effective control over them;
 - (c) that they and their invitees exercise caution at all times and not behave in a manner that is likely to interfere with the use and enjoyment of other Owners or Occupiers or their invitees;
 - (d) that they book any relevant Recreation Area through any reservation system that may be put in place by the Body Corporate and the Caretaker;
 - (e) that all users of the Recreation Areas comply with any rules (including signage) made from time to time by the Committee;
 - (f) that they or their invitees does not without proper authority operate, adjust or interfere with the operation of equipment associated with the Recreation Areas;
 - (g) they do not use the Recreation Areas between the hours of 11:00pm and 7:00am or such lawful hours as agreed to by the Committee and the Caretaker; and
 - (h) they and their invitees use any plant and equipment in accordance with the directions or instructions given by the Committee or the Caretaker.
- 22.2 All Owners and Occupiers of Lots acknowledge that the Body Corporate and the Caretaker may make rules from time to time regarding the use of the Recreation Area including the right to operate a reservation system.
- 22.3 The Recreation Area must only be used by the Owners and Occupiers of Lots and their guests or any other person or persons authorised by the Body Corporate.
- 22.4 Notwithstanding any other clause of these by-laws,
- (a) Rooftop areas may only be accessed between the hours of 8.00am and 9.00pm;
 - (b) Guests must at all times be accompanied by Lot owners or occupiers in the roof top area;

- (c) The area must be left clean and tidy after use;
- (d) Access to the area must be properly secured at all times.

23 WINDOW TREATMENTS SUCH AS CURTAINS/SIMILAR VENETIAN BLINDS AND SHUTTERS

- 23.1 An Owner or Occupier of a Lot shall not hang curtains visible from outside the Lot unless those curtains have a white backing or unless such colour and design have been approved by the Committee. An Owner or Occupier shall not install, renovate and/or replace a curtain backing or window treatment without having the colour and design of same approved by the Committee. In giving such approval, the Committee shall ensure so far as practicable that curtain backing and window treatment used in all units have colours that are sympathetic to the tones of the Building and present an aesthetic appearance when viewed from Common Property or any other Lot.

24 AUCTION SALES

- 24.1 An Owner of a Lot shall not permit any auction sale to be conducted or to take place in the Owner's Lot or in the dwelling or upon the Scheme Land without prior approval in writing from the Committee.

25 CORRESPONDENCE AND REQUESTS TO THE SECRETARY OF THE BODY CORPORATE

- 25.1 All complaints, applications or requests to the Body Corporate or its Committee shall be addressed in writing to the Secretary of the Body Corporate.
- 25.2 An Owner or Occupier of a Lot shall not give instructions to a Body Corporate contractor. All requests are to be submitted in writing to the Caretaker or Secretary.

26 COPY OF BY-LAWS TO BE PRODUCED UPON REQUEST

Where any Lot or Common Property is leased or rented, otherwise than to an Owner of a Lot, the lessor or as the case may be, landlord shall cause to be produced to the Lessee or tenant for inspection a copy of the By-Laws.

27 RECOVERY OF COSTS

- 27.1 An Owner shall pay on demand the whole of the Body Corporate costs and expenses (including Solicitor's costs on an indemnity basis) which amount shall be deemed to be a liquidated debt due, in recovering all and any levies or moneys duly levied upon such owner of the Body Corporate pursuant to the Act.
- 27.2 The Body Corporate may charge and recover interest at an annual rate determined by the Body Corporate by ordinary resolution in general meeting on any unpaid levies or other monies payable by an Owner to the Body Corporate.
- 27.3 Any expense incurred by the Body Corporate in remedying any breach of the Act or the By-laws shall be deemed to be a debt due by the Owner of the Lot whose Occupier caused such expense to the Body Corporate.

28 POWER OF BODY CORPORATE COMMITTEE

- 28.1 The Committee may make rules relating to the Common Property not inconsistent with these By-laws and the same shall be observed by the Owners and Occupiers of Lots unless and until they are disallowed or revoked by a majority resolution at a general meeting of the Body Corporate.
- 28.2 The Committee may retain such agents and servants it deems appropriate in carrying out its duties.

29 AIR CONDITIONING

- 29.1 No air conditioning system may be installed within a Lot or on Common Property without the prior written approval of the Body Corporate. The Body Corporate may establish standards for the type, noise, disposal, vibration, method of installation, location of condensers, provision of air, water reticulation and

the like associated with the installation of any air conditioning unit.

30 BULK SUPPLY OF ELECTRICITY OR OTHER UTILITY SERVICES

- 30.1 The Body Corporate may supply electricity or other utility services for the benefit of an Owner or Occupier of a Lot and in such case this By-law shall apply.
- 30.2 The Body Corporate may purchase reticulated electricity or other services on the most economical basis for the whole of the Scheme Land from the relevant authority.
- 30.3 The Body Corporate may sell reticulated electricity or other services to Occupiers. Occupiers are not compelled to buy electricity or other services from the Body Corporate.
- 30.4 The Body Corporate must arrange for the installation of a separate electricity and/or other service meter for each Lot.
- 30.5 The Body Corporate is not required to supply to the Occupier of a Lot electricity or other service requirements beyond those requirements which the relevant authority could supply at a particular time.
- 30.6 Insofar as it is lawful, the price to be charged by the Body Corporate to an occupier of a Lot for the supply of electricity or other service will be the total of:
- (a) the price paid by the Body Corporate for the electricity or other service; and
 - (b) any additional cost incurred by the Body Corporate reading meters, issuing accounts and doing any other things required for the supply of electricity or other service.
- 30.7 The Body Corporate may render accounts to an Occupier supplied with electricity or other services under this By-law and such accounts are payable to the Body Corporate within 14 days of delivery of such accounts.
- 30.8 In respect of an account that has been rendered pursuant to these By-laws, the Occupier is liable jointly and severally with any person who was liable to pay that electricity or other service account when that Occupier of a Lot became the Occupier of the Lot.
- 30.9 In the event that a proper account for the supply of reticulated electricity or other service is not paid by the due date for payment the Body Corporate is entitled to:
- (a) recover the amount of the unpaid account or accounts (whether or not a formal demand has been made) as a liquidated debt due to it in any court of competent jurisdiction; and/or
 - (b) disconnect the supply of reticulated electricity or other service to the relevant Lot.
- 30.10 The Body Corporate is not, under any circumstances whatsoever, responsible for or liable for any failure of the supply of electricity or other service due to breakdowns, repairs, maintenance, strikes, accidents or any other causes regardless of their class or description.
- 30.11 The Body Corporate may, from time to time, determine a security deposit to be paid by each Occupier who is entitled to the supply of reticulated electricity or other service as a guarantee against non-payment of accounts for the supply of reticulated electricity or other service.
- 30.12 In this By-law references to the Body Corporate include any person engaged by the Body Corporate to supply the services.

31 SALE OF LOTS

- 31.1 Despite any other By-law the Original Owner, its agents and any person authorised by it may:
- (a) use any Lot it owns as a display Lot and sales Lot;

- (b) place any signs and other advertising and display material in and about the Lot and about the Common Property; and
- (c) together with persons authorised by it, pass over the Common Property to gain access to and degrees from any Lot.

31.2 Despite any other By-law any other Owner of a Lot may not erect any sign indicating the sale of a Lot within 12 months of registration of the Scheme.

32 PAY TELEVISION / BROADBAND / PHONE / FAX / MODEM / RECEIVERS / ANTENNAE

32.1 The Committee has the power to allow a person to install cabling and associated items to allow the provision of cable or satellite television/computer/phone/fax/modem services to the Scheme Land and to enter into agreements with the providers of such services as deemed acceptable by the Committee from time to time.

32.2 Outside wireless and television aerials or antennae may not be erected without the written consent of the Committee.

33 RIGHT OF ENTRY

33.1 An Owner or Occupier shall allow entry into their Lot by the Body Corporate and its authorised parties for all purposes including but not limited to the inspection of the interior of a Lot to test the electrical, gas or water installation or equipment and to trace and repair any leakage or defect in the installation or equipment (at the expense of the Owner in cases where such leakage or defect is due to any act or default of the Owner or their tenants, guests, servants and agents) associated with the Body Corporate, the Building and the By-laws upon reasonable notice. In the absence of any other special circumstances, twenty-four hours written notice shall be deemed reasonable.

33.2 Despite subsection 1, no notice shall be required in the case of emergency.

33.3 The Body Corporate shall ensure as little disruption is caused to the Owner or Occupier of a Lot as is reasonable in the circumstances when exercising any rights of entry.

34 CARETAKER'S AND LETTING AGENTS' EQUIPMENT

34.1 Any Caretaker or letting agent appointed by the Body Corporate shall be entitled to install, maintain and replace any equipment on the Common Property reasonably required for the operation of any services allowed under any agreements with the Body Corporate including PABX, pool cleaning, vending machines and cleaning equipment

35 HARD SURFACE FLOORING AND NOISE TRANSMISSION

35.1 The Owner or Occupier of a Lot shall not install within their Lot including any balcony area (if applicable) any floor treatment that is a hard surface e.g. timber or tile, without the consent of the Body Corporate. In granting its consent the Body Corporate may require compliance with and requirements of the Brisbane City Council or otherwise to meet good building practice, including complying with any Australian Standards.

35.2 Where the floor treatment of an area of a Lot, including a balcony area, is a hard surface the Occupier shall take reasonable steps to minimise the noise furniture and other like objects make when moved on that surface, particularly noise transmission through to adjacent Lots. The use of floor rugs and felt pads on furniture legs are examples of measures which should be taken to reduce such noise transmission.

35.3 Where an Owner or Occupier fails to comply with the terms of this By-law then the Owner or Occupier will at their expense remove any hard surface floor treatment upon receiving written notice from the Body Corporate.

36 STORAGE AREAS

- 36.1 An Owner or Occupier of a Lot shall not install any storage device on any part of their Lot or Exclusive Use Area without the consent of the Body Corporate.
- 36.2 In determining whether to grant its consent the Body Corporate may only consent to the installation of a storage device where:
- (a) the storage device complies with and has obtained all approvals required to be lawful; and
 - (b) does not impede quiet use and enjoyment of another Owner or Occupiers Lot or Exclusive Use Area.

37 RESTRICTED ACCESS AREAS

- 37.1 Any areas of the Common Property used for:
- (a) electrical substations, switchrooms, or control panels;
 - (b) fire service control panels;
 - (c) telephone exchanges; and
 - (d) other services to the Lots, Common Property and Exclusive Use Areas (or any of them)
- may be kept locked by the Committee (or its appointed representative) unless otherwise required by law. Persons may not enter or open such locked areas without the prior consent of the Committee.
- 37.2 The Committee may use appropriate areas of the Common Property the store plant and equipment used for the performance of the Body Corporate's duties in respect of the Common Property. Any such areas may be locked and access is prohibited without prior consent of the Committee.

38 FIRE CONTROL

- 38.1 An Owner or Occupier of a Lot must not use or interfere with any fire safety equipment except in case of an emergency, and must not obstruct any fire stairs or fire escape.
- 38.2 The Body Corporate or an Owner or Occupier of a Lot must, in respect of the Scheme or the Lot, as appropriate:
- (a) consult with any relevant authority as to an appropriate fire alarm or fire sprinkler system for the Scheme or the Lot;
 - (b) ensure the provision of all adequate equipment to fight fire or the spread of fire in or from the Scheme or the Lot to the satisfaction of the relevant authorities; and
 - (c) take all reasonable steps to ensure compliance with fire laws in respect of the Scheme or the Lot.

39 BODY CORPORATE AGREEMENTS

- 39.1 Subject to the Act the Body Corporate may enter into agreements with any other party on such terms as it may decide in its sole discretion including:
- (a) an agreement for the caretaking of the Common Property and letting of the Lots from the Scheme Land;
 - (b) an agreement for the management of the Body Corporate including appointing a body corporate manager including carrying out tasks involving the duties of the secretary and treasurer;

- (c) an agreement with the Original Owner concerning the further development of the Scheme Land and the recording of any new community management statement;
- (d) an agreement with any party concerning the utility infrastructure and its supply and maintenance;
- (e) an agreement with any energy supplier;
- (f) an agreement with any cable television, satellite television, broadband, computer, fax, modem, PABX or phone service provider; and
- (g) an agreement to grant any licence or special rights or occupation authority to any party concerning use and occupation of any part of the Common Property not previously granted exclusive use to any other Lot Owner.
- (h) an agreement with any neighbouring community titles scheme ("Neighbouring Scheme") authorizing members of the Neighbouring Scheme to access the Recreation Area, providing:
 - (i) the Neighbouring Scheme contributes to the costs of maintaining and upkeep of the Recreation Area on a pro rata basis with the members of the Scheme; and
 - (ii) the Neighbouring Scheme has been created from the Base Parcel.

40 EXCLUSIVE USE (attached plan)

- 40.1 The Occupier of each Lot set out in Schedule E is entitled to the exclusive use and enjoyment for the nominated purpose of that part of the Common Property allocated to the Lot in Schedule E and identified on the sketch marked "Annexure A" attached to schedule E.
- 40.2 The Occupier of a Lot which has the benefit of an Exclusive Use Area must keep that area clean, tidy and in good repair
- 40.3 The Body Corporate, its authorised parties and any Caretaker may enter upon such Exclusive Use Areas to carry out any inspection or works concerning the Building or the utility infrastructure.

41 EXCLUSIVE USE (allocation)

- 41.1 This exclusive use By-Law authorises the Original Owner or its agent to allocate parts of the Common Property for carparking, private yard and storage purposes.
- 41.2 The Occupier of each Lot to which this By-law attaches shall have exclusive use and enjoyment of that part of the Common Property allocated.
- 41.3 The Original Owner or its agent shall give the details of the allocation to the Body Corporate.
- 41.4 The Body Corporate shall ensure the details of the allocation shall be recorded in a new community management statement.
- 41.5 The Body Corporate, its authorised parties and any caretaker may enter upon such exclusive use areas to carry out any inspection or works concerning the Building or the utility infrastructure.

42 BRISBANE CITY COUNCIL CONDITIONS

- 42.1 Despite any other By-Law, the Body Corporate and the lot owners shall comply with the conditions of the Development Approval concerning the Scheme, including, but not limited to, ensuring:
 - (a) All balconies/verandahs/terraces/ remain unenclosed with no shutters, glazing, louvres or similar permanent fixtures.
 - (b) The internal footpaths/pedestrian circulation routes, landscaping, driveway, and car/vehicle turning area as shown on the approved plans of layout is to be included in common property and is not to be included in any private lot entitlement and/or designated for the exclusive use of any dwelling unit or

tenancy

- (c) All privacy screening devices are to remain fitted at all times.
- (d) Maintain parking on the site for a total of 66 cars and for the loading and unloading of vehicles within the site. A minimum 58 spaces are to be dedicated to residents and minimum of 8 car parking spaces are to be provided for visitor parking and not to be included within a lot entitlement or exclusive use.
- (e) Parking spaces are not to be made available to the general public and there is to be no advertising signage erected on or in the vicinity of the site advertising the availability of car parking to the general public.
- (f) Maintain a suitable system of lighting, to operate from dusk to dawn, within all areas where the public will be given access including between vehicle entrances to the site and visitors car parking spaces.

[Note: This by-law may be amended to include conditions in any development approval.]

45. DEFINITIONS

45.1 In these By-laws, the following terms have the following meaning unless the context otherwise requires:

- (a) **“Act”** means the Body Corporate and Community Management Act 1997 as amended from time to time.
- (b) **“Base Parcel”** means the land described as lot 146 on RP 88878, Title Reference 13183070 and any adjacent or neighboring land;
- (c) **“Body Corporate”** means the body corporate for the Scheme established pursuant to the Act;
- (d) **“Building”** building or buildings and/or parts thereof including the Lots erected upon the Scheme Land;
- (e) **“By-laws”** means the By-laws for the Scheme;
- (f) **“Caretaker”** means the person or corporation that has entered into, or is to enter into, the Caretaking and Letting Agreement. If there is no such person, the Committee may nominate a person as the Caretaker for the purposes of these By-laws;
- (g) **“Caretaking and Letting Agreement”** means the agreement (or agreements) entered into, or to be entered into, between the Caretaker and the Body Corporate under which the Caretaker is required, amongst other things, to keep the Common Property in good order. It includes any agreement that replaces or extends a previous agreement;
- (h) **“Committee”** means the Committee of the Body Corporate appointed pursuant to the Act;
- (i) **“Committee’s Representative”** means a member of the Committee appointed from time to time for the purpose of representing the Committee;
- (j) **“Common Property”** means the common property for the Scheme.
- (k) **“Council”** means the Brisbane City Council;
- (l) **“Development Approval”** means the approval issued by Council having Application Reference No. A004595773 and any replacement, varied, substituted or additional approval obtained by the Original Owner and any of its successors concerning the Scheme Land and the Base Parcel;
- (m) **“Development Deed”** means the deed entered into, or to be entered into by the Body Corporate with the Original owner concerning the development in the Scheme;
- (n) **“Lot”** means a lot in the Scheme;
- (o) **“Original Owner”** has the meaning given to it in the Act as well as any nominee of the Original Owner;

- (p) **“Owner”** and **“Occupier”** has the meanings given to them in the Act;
- (q) **“Plan”** means the registered survey plan for the Scheme Land;
- (r) **“Recreation Areas”** means all improvements on the Common Property used for, or intended to be used for, recreation and/or leisure activities.
- (s) **“Scheme”** means the community title scheme for the Parkinson Residences Community Titles Scheme;
- (t) **“Scheme Land”** means the land contained within the Scheme;
- (u) **“Secretary”** means the secretary of the Body Corporate.

| |
|--|
| SCHEDULE D OTHER DETAILS REQUIRED/PERMITTED TO BE INCLUDED |
|--|

1. Statutory Easements

Each of the Lots in the Scheme¹ may be affected by the following statutory easements pursuant to Section 67 to 70 of the *Body Corporate & Community Management Act 1997*: -

- (1) easements for support;
- (2) easements in favour of lots for utility services and utility infrastructure;
- (3) easements in favour of Common Property for utility services and utility infrastructure;
- (4) easements for shelter;
- (5) easements for projections;
- (6) easements for maintenance or replacement of a building on or close to the boundary of a lot.

¹ Some or all of the lots may not be affected by each of the statutory easements. This provision will be finalised in the CMS on or by registration

2. Services Easements and Services Location Diagram

Each of the Lots in the Scheme² may be affected by the Services Easements specified in the Services Location Diagram which may be required to be inserted in this document. If a diagram is attached the service easements will be created for basic utility services such as water, gas, electricity, telephone, computer data or TV lines, sewerage and drainage

² This diagram (if applicable) will be prepared on completion of construction. Some or all of the Lots may be affected by such Service Easements. This provision will be finalised in the CMS on or by registration.

| | | |
|---------------------|--|-----------|
| Lot 28 on SP 321895 | Area 28A on sketch marked 'Sketch of Exclusive Use Areas' at Annexure A Area 28B on sketch marked 'Sketch of Exclusive Use Areas' at Annexure A | Courtyard |
| Lot 29 on SP 321895 | Area 29A on sketch marked 'Sketch of Exclusive Use Areas' at Annexure A Area 29B on sketch marked 'Sketch of Exclusive Use Areas' at Annexure A | Courtyard |

ANNEXURE A
EXCLUSIVE USE PLAN

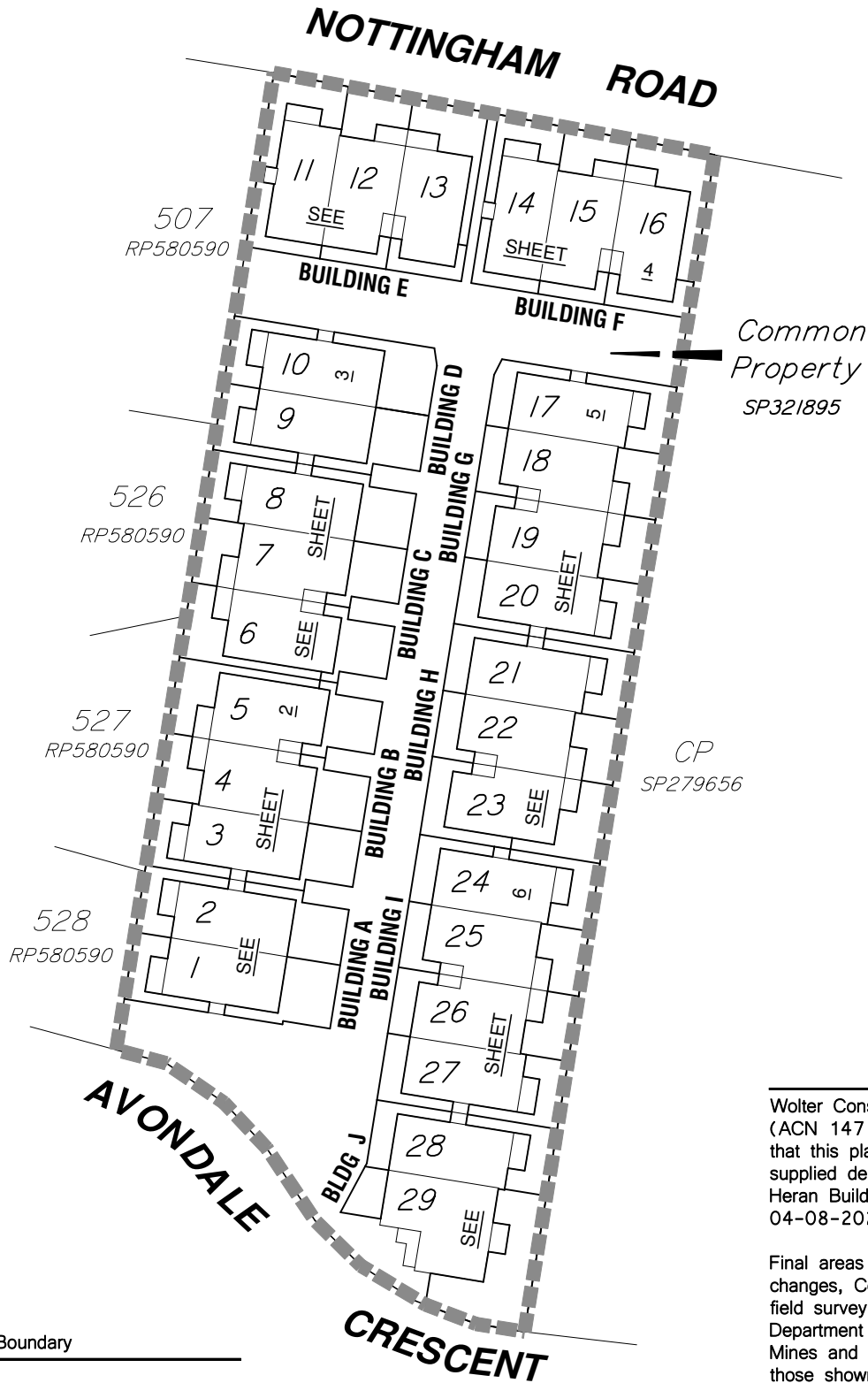

--- CTS Boundary

Notes:
Exclusive use areas are defined by structural features unless dimensioned.

Unauthorised reproduction or amendment of this document is prohibited.

Wolter Consulting Group Pty Ltd (ACN 147 343 084) hereby certify that this plan has been prepared from supplied design drawings provided by Heran Building Group on 04-08-2020.

Final areas are subject to design changes, Council approval, construction, field survey and registration with the Department of Natural Resources, Mines and Energy and may differ from those shown on this plan.

Authorised Delegate Date



Scale 1:750 @ A4
Lengths are in Metres.
10 0 10 20 30



Sketch of Exclusive Use Areas
in Common Property on SP321895
Level A

_____ CTS
Title Reference:

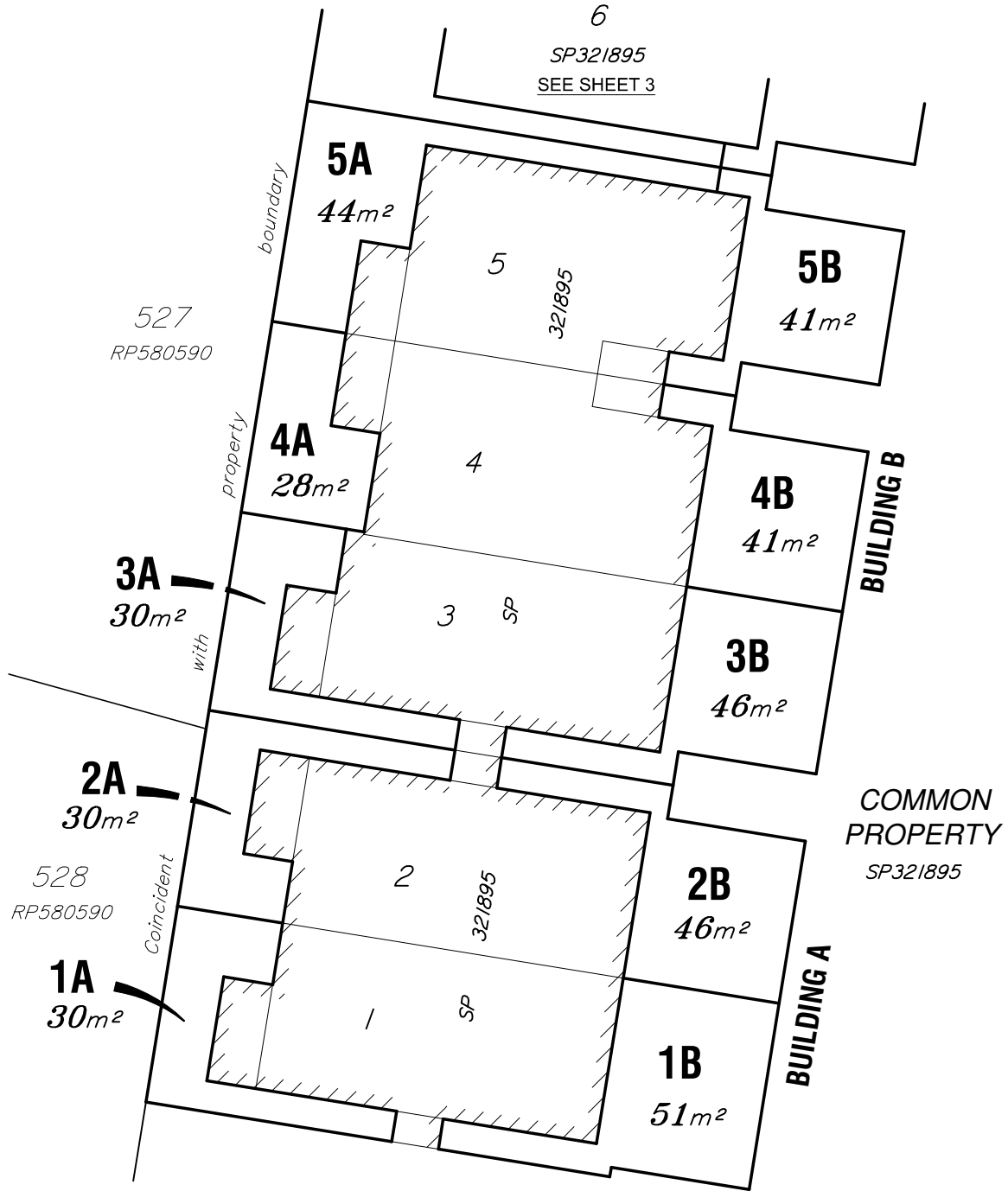
| | | |
|-------------------------------|--------------|---------|
| Surveyor N.Donaldson | | |
| Date Drawn 18-08-2020 | Sheet 1 | of 6 |
| Drawing Number 20-0291S-01 | Version A | |



LEVEL A

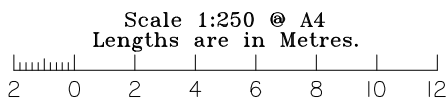

 Denotes face of building
 Denotes edge of concrete

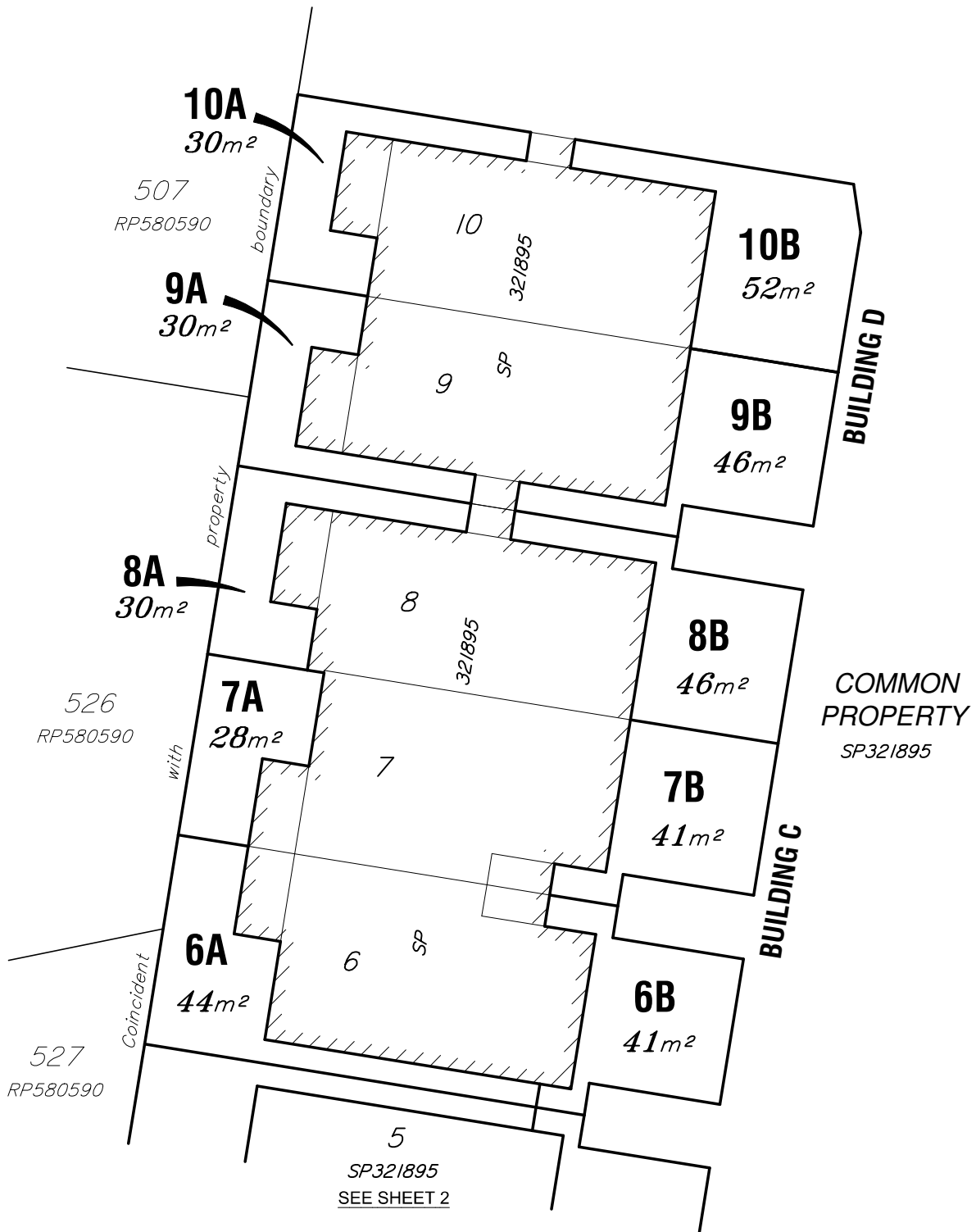

| | |
|----------------|---------|
| Sheet | No |
| 2 | 6 |
| Drawing Number | Version |
| 20-0291S-01 | A |



LEVEL A

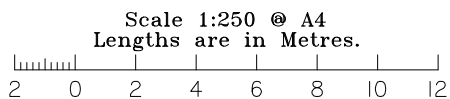

 Denotes face of building
 Denotes edge of concrete

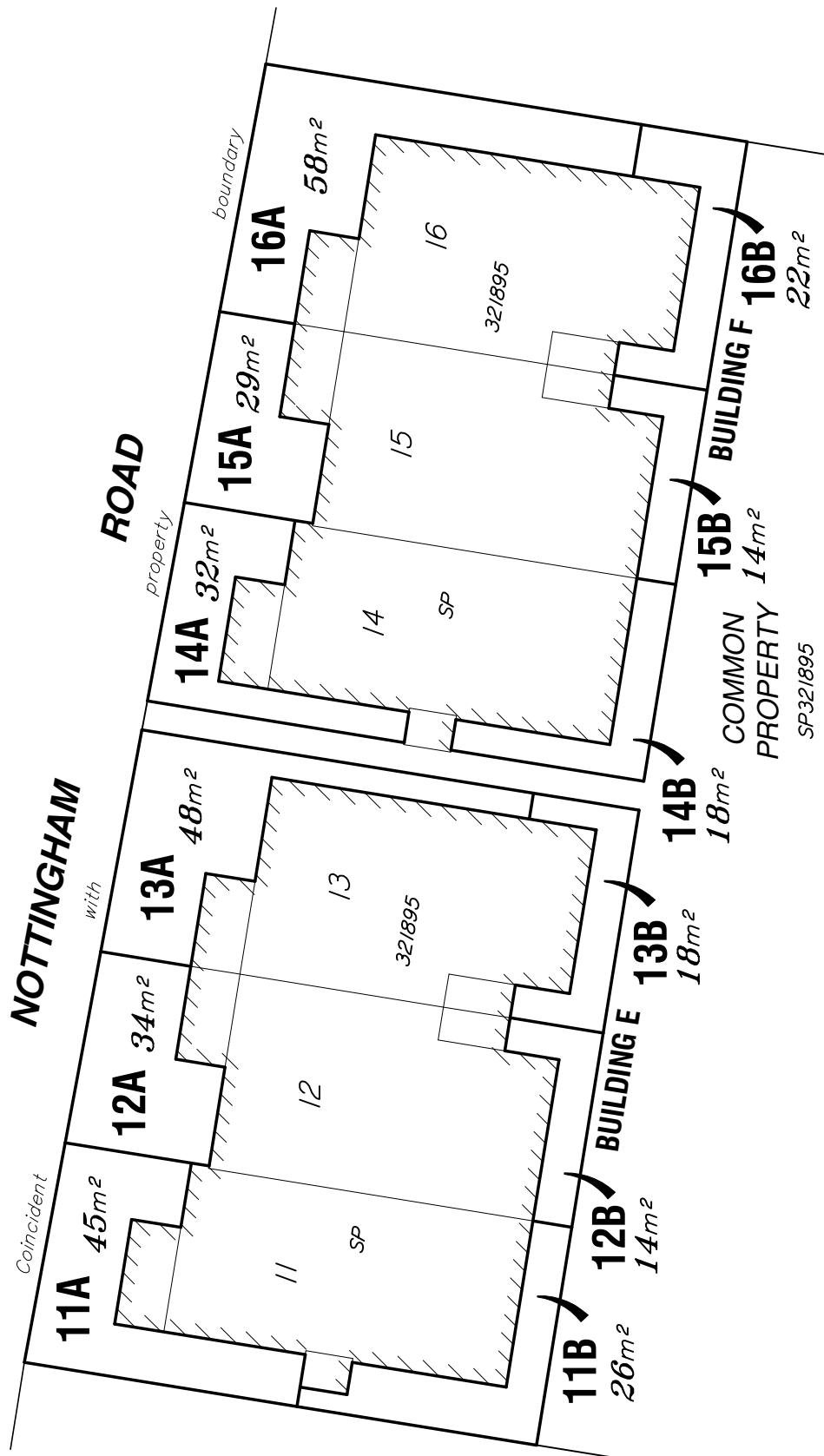

| | |
|----------------|---------|
| Sheet | No |
| 3 | 6 |
| Drawing Number | Version |
| 20-0291S-01 | A |



LEVEL A

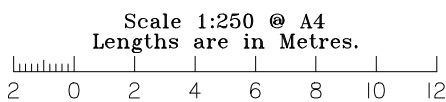

-  Denotes face of building
-  Denotes edge of concrete

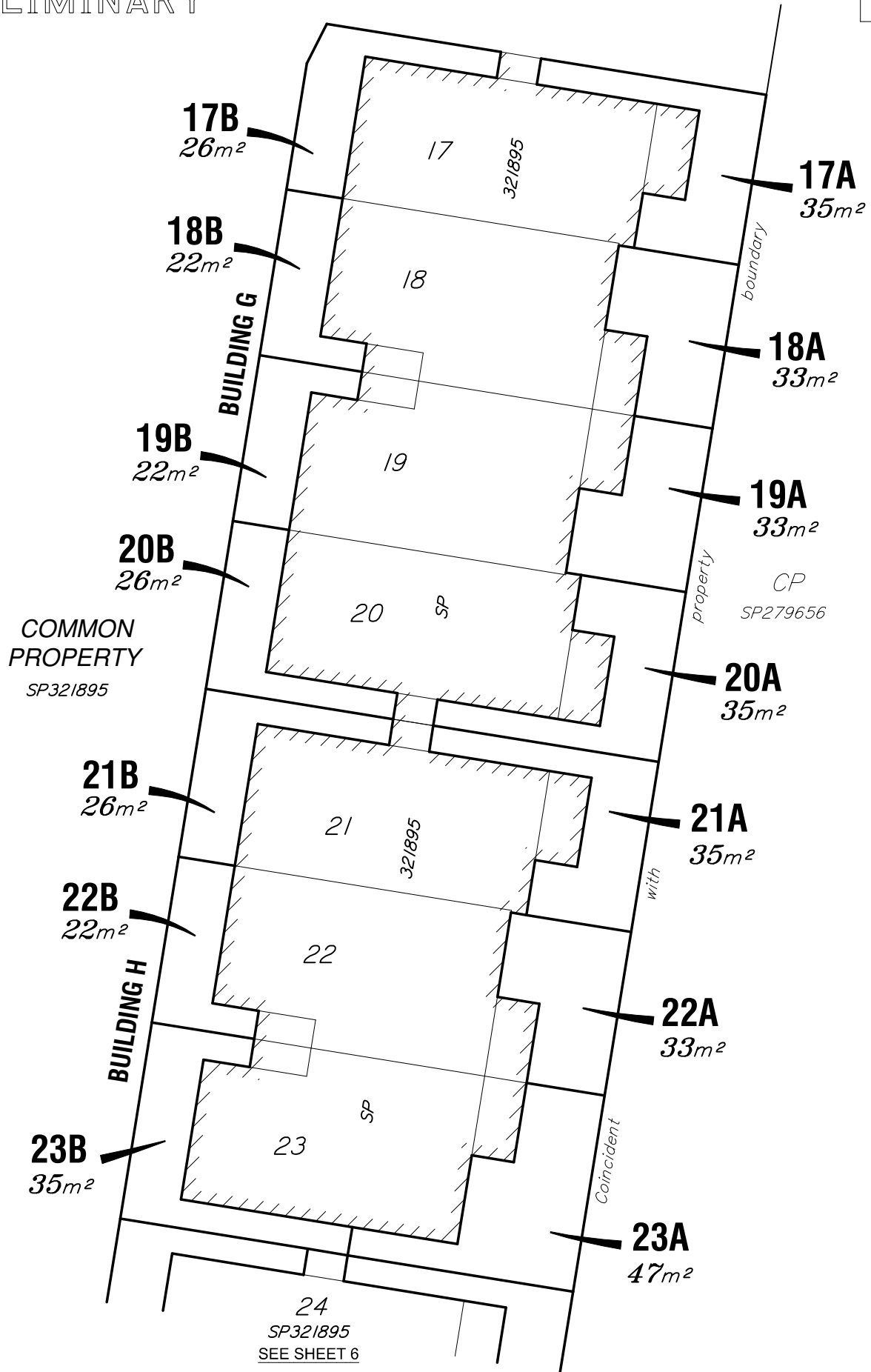

| | |
|----------------|---------|
| Sheet | No |
| 4 | 6 |
| Drawing Number | Version |
| 20-0291S-01 | A |



LEVEL A

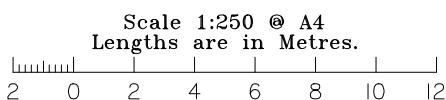

-  Denotes face of building
-  Denotes edge of concrete

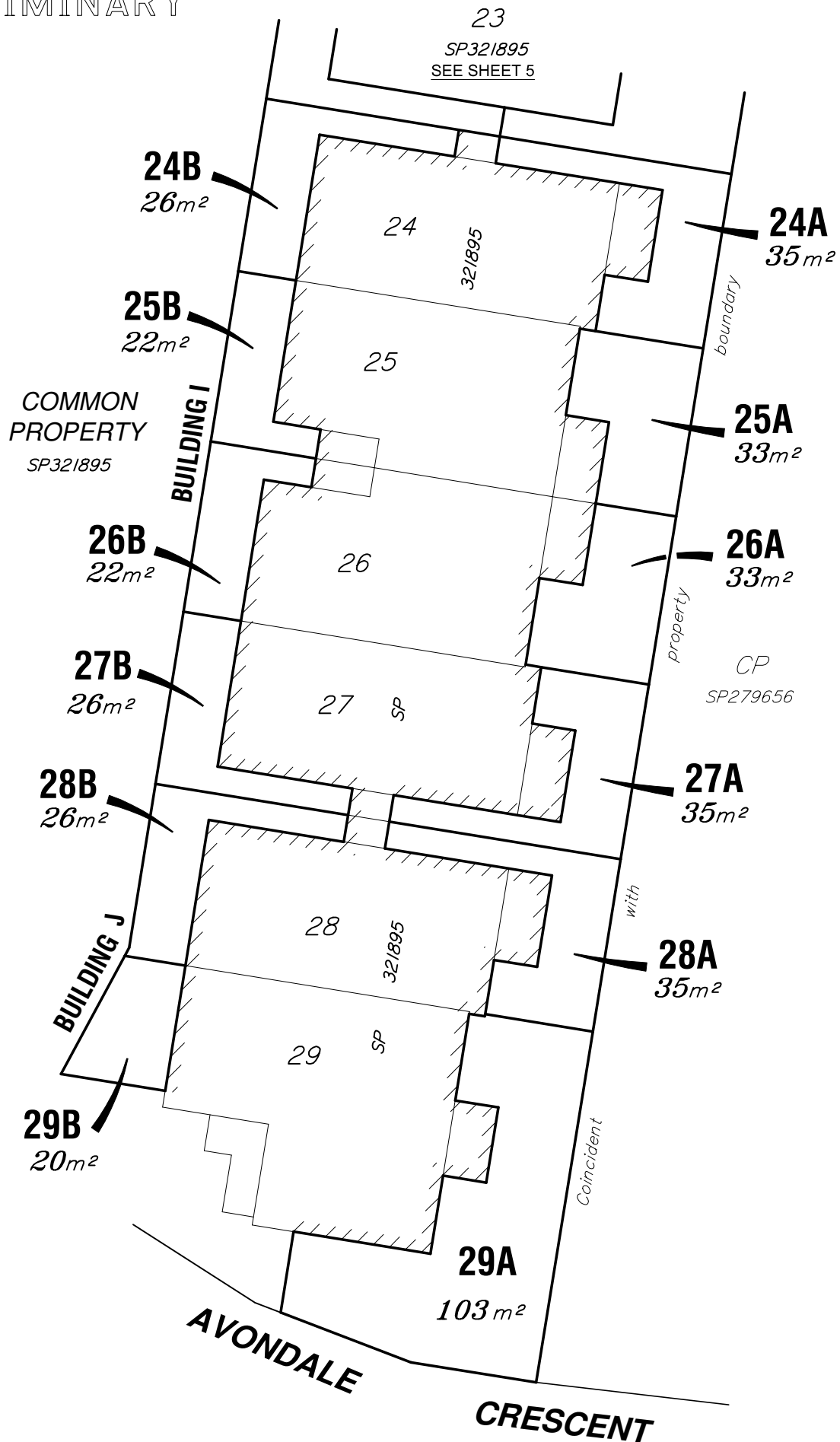

| | |
|----------------|----|
| Sheet | No |
| 5 | 6 |
| Drawing Number | |
| 20-0291S-01 | |
| Version | |
| A | |



LEVEL A

 Denotes face of building
 Denotes edge of concrete

Scale 1:250 @ A4
Lengths are in Metres.

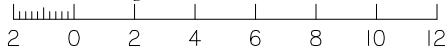

| | |
|----------------|---------|
| Sheet | No |
| 6 | 6 |
| Drawing Number | Version |
| 20-0291S-01 | A |

ANNEXURE B
SERVICES LOCATION DIAGRAM

Schedule 7 – Budgets and Contributions

**PARKINSON RESIDENCES
PROPOSED BUDGET**

ADMINISTRATION FUND

Expenses

| | | |
|----------------------------------|--|-----------|
| Bank Charges | | 50.00 |
| Caretaker Fees | | 29,000.00 |
| Cleaning materials | | 50.00 |
| Community Power | | 1,500.00 |
| Communications and disbursements | | 1,885.00 |
| Fees and Permits | | 100.00 |
| Fire Hydrants | | 250.00 |
| Pest Control | | 1,800.00 |
| Secretarial Fees | | 4,060.00 |
| Sundries | | 150.00 |
| Tax return | | 250.00 |
| Telephone | | 165.00 |

Repairs and maintenance

| | | |
|------------------------------------|-----------------|----------|
| - Building | 1,000.00 | |
| - Electrical | 200.00 | |
| - Gardens and grounds materials | 300.00 | |
| - Plumbing | 200.00 | |
| - Pool Chemicals | 900.00 | |
| - Stormwater Treatment Maintenance | <u>3,000.00</u> | 5,600.00 |

Sub Total **44,860.00**

GST **4,486.00**

TOTAL **49,346.00**

AGGREGATE CONTRIBUTION SCHEDULE LOT ENTITLEMENTS **4645**

LEVY PER LOT ENTITLEMENT PER ANNUM **10.62**

LEVY PER LOT ENTITLEMENT PER WEEK **0.20**

SINKING FUND

Provision for Future Expenditure 10,150.00

GST 1,015.00

TOTAL **11,165.00**

LEVY PER LOT ENTITLEMENT PER ANNUM **2.40**

LEVY PER LOT ENTITLEMENT PER WEEK **0.05**

INSURANCE

Insurances

- Building & Public Liability 4,925.00

GST 492.50

TOTAL **5,417.50**

AGGREGATE INTEREST SCHEDULE LOT ENTITLEMENTS **7817**

LEVY PER LOT ENTITLEMENT PER ANNUM **0.69**

LEVY PER LOT ENTITLEMENT PER WEEK **0.01**

**PARKINSON RESIDENCES
SCHEDULE OF LOT ENTITLEMENTS**

| LOT NUMBER | ENTITLEMENTS | | ADMIN FUND PER ANNUM | SINKING FUND PER ANNUM | INSURANCE PER ANNUM | Caretaker's Fee pa <i>(included in Admin Fund pa)</i> | Body Corporate Manager's Fee pa | LEVY PER ANNUM | LEVY PER WEEK |
|------------|--------------|-------------|----------------------|------------------------|---------------------|--|---------------------------------|------------------|-----------------|
| | CONTRIBUTION | INTEREST | | | | | | | |
| 1 | 160 | 267 | 1,699.75 | 384.59 | 185.04 | 1,098.82 | 153.83 | 2,269.38 | 43.64 |
| 2 | 160 | 267 | 1,699.75 | 384.59 | 185.04 | 1,098.82 | 153.83 | 2,269.38 | 43.64 |
| 3 | 160 | 267 | 1,699.75 | 384.59 | 185.04 | 1,098.82 | 153.83 | 2,269.38 | 43.64 |
| 4 | 160 | 267 | 1,699.75 | 384.59 | 185.04 | 1,098.82 | 153.83 | 2,269.38 | 43.64 |
| 5 | 160 | 272 | 1,699.75 | 384.59 | 188.51 | 1,098.82 | 153.83 | 2,272.85 | 43.71 |
| 6 | 160 | 272 | 1,699.75 | 384.59 | 188.51 | 1,098.82 | 153.83 | 2,272.85 | 43.71 |
| 7 | 160 | 267 | 1,699.75 | 384.59 | 185.04 | 1,098.82 | 153.83 | 2,269.38 | 43.64 |
| 8 | 160 | 267 | 1,699.75 | 384.59 | 185.04 | 1,098.82 | 153.83 | 2,269.38 | 43.64 |
| 9 | 160 | 267 | 1,699.75 | 384.59 | 185.04 | 1,098.82 | 153.83 | 2,269.38 | 43.64 |
| 10 | 160 | 267 | 1,699.75 | 384.59 | 185.04 | 1,098.82 | 153.83 | 2,269.38 | 43.64 |
| 11 | 160 | 270 | 1,699.75 | 384.59 | 187.12 | 1,098.82 | 153.83 | 2,271.46 | 43.68 |
| 12 | 160 | 267 | 1,699.75 | 384.59 | 185.04 | 1,098.82 | 153.83 | 2,269.38 | 43.64 |
| 13 | 160 | 275 | 1,699.75 | 384.59 | 190.59 | 1,098.82 | 153.83 | 2,274.93 | 43.75 |
| 14 | 160 | 267 | 1,699.75 | 384.59 | 185.04 | 1,098.82 | 153.83 | 2,269.38 | 43.64 |
| 15 | 160 | 267 | 1,699.75 | 384.59 | 185.04 | 1,098.82 | 153.83 | 2,269.38 | 43.64 |
| 16 | 160 | 277 | 1,699.75 | 384.59 | 191.97 | 1,098.82 | 153.83 | 2,276.31 | 43.78 |
| 17 | 160 | 268 | 1,699.75 | 384.59 | 185.73 | 1,098.82 | 153.83 | 2,270.08 | 43.66 |
| 18 | 160 | 268 | 1,699.75 | 384.59 | 185.73 | 1,098.82 | 153.83 | 2,270.08 | 43.66 |
| 19 | 160 | 268 | 1,699.75 | 384.59 | 185.73 | 1,098.82 | 153.83 | 2,270.08 | 43.66 |
| 20 | 160 | 268 | 1,699.75 | 384.59 | 185.73 | 1,098.82 | 153.83 | 2,270.08 | 43.66 |
| 21 | 160 | 268 | 1,699.75 | 384.59 | 185.73 | 1,098.82 | 153.83 | 2,270.08 | 43.66 |
| 22 | 160 | 268 | 1,699.75 | 384.59 | 185.73 | 1,098.82 | 153.83 | 2,270.08 | 43.66 |
| 23 | 160 | 275 | 1,699.75 | 384.59 | 190.59 | 1,098.82 | 153.83 | 2,274.93 | 43.75 |
| 24 | 160 | 268 | 1,699.75 | 384.59 | 185.73 | 1,098.82 | 153.83 | 2,270.08 | 43.66 |
| 25 | 160 | 270 | 1,699.75 | 384.59 | 187.12 | 1,098.82 | 153.83 | 2,271.46 | 43.68 |
| 26 | 160 | 270 | 1,699.75 | 384.59 | 187.12 | 1,098.82 | 153.83 | 2,271.46 | 43.68 |
| 27 | 160 | 268 | 1,699.75 | 384.59 | 185.73 | 1,098.82 | 153.83 | 2,270.08 | 43.66 |
| 28 | 160 | 268 | 1,699.75 | 384.59 | 185.73 | 1,098.82 | 153.83 | 2,270.08 | 43.66 |
| 29 | 165 | 287 | 1,752.87 | 396.60 | 198.90 | 1,133.15 | 158.64 | 2,348.38 | 45.16 |
| | 4645 | 7817 | 49,346.00 | 11,165.00 | 5,417.50 | 31,900.00 | 4,466.00 | 65,928.50 | 1,267.86 |

Schedule 8 – Schedule of Finishes

Luxury Inclusions

Totally liveable and all backed by Heran's six month maintenance and six year structural guarantee (QBCC)

KITCHEN

| | |
|---------------------|--|
| Bench Top | Manufactured Stone (Square Edge) |
| Doors | Laminate |
| Splash back | Glass |
| Kitchen Sink | S/steel sink with mixer tapware |
| Appliances | European s/s multifunction oven, cook-top, rangehood and s/s dishwasher or similar |

BATHROOM & LAUNDRY

| | |
|-----------------|---|
| Showers | Semi-frameless glass shower screen with pivot action door |
| Bath | Acrylic or similar |
| Vanities | Manufactured stone top (square edge) with laminate doors, semi recessed basin or similar with mixer tapware |
| Toilets | Water saving dual flush cisterns to WC's |
| Laundry | 30L slimline tub & unit with quality tapware |

*PLEASE NOTE: Proposed finishes are subject to change. Heran Building Group reserves the right to substitute similar colours or products depending on availability and/or cost constraints. Correct July 2020

INDOOR

| | |
|-------------------------|---|
| Air-Conditioning | Split system to living area & master bedroom |
| Ceiling Fans | To all bedrooms |
| Electrical | Telephone/TV points etc, earth leakage safety switch, smoke detectors & generous amount of lighting & power points. Television Antenna |
| Insulation | Ceiling batts |
| Paint | Washable paint to walls |
| Doors | Modern flush panel with stylish door furniture |
| Robes | Mirror Sliding Doors |
| Stairs | Carpeted; aluminium balustrade & timber rails |
| Blinds | Roller blinds and venetians throughout |
| Flooring | Porcelain tiles or stone polymer & carpet |

OUTDOOR

| | |
|------------------------------------|---|
| Brick | Rendered or face brick external finish |
| Roof | Colorbond Roofing |
| Framing | Timber frame & roof trusses |
| Garage | Sectional overhead door with colorbond finish & remote control unit |
| Windows & Sliding Doors | Powder coat aluminium with barrier screens (downstairs only) |
| Termite Protection | Penetrations & perimeter system |
| Hot Water System | Electric storage unit or electric continuous hot water unit |
| Courtyard | Private fully fenced |
| Clothesline | Hills wall mounted |
| Amenities | Swimming pool |
| Landscaping | Professional landscaping to townhomes & common areas |
| Parking | Ample visitor car parking |
| Driveways | Concrete driveways (exposed) |
| Internal Roads | Concrete |

Schedule 9 – Power of Attorney Disclosure Statement

1. Unless defined in this power of attorney disclosure statement, terms that have a defined meaning in the contract of sale to be entered into between the Seller and the Buyer (**Contract**) have the same meaning in this statement.
2. This power of attorney disclosure statement is given by the Seller to the Buyer in compliance with section 219 of the *Body Corporate and Community Management Act 1997*(Qld) (**BCCM Act**) or section 211 of the Act (as the case may be).
3. Under clause 9.3 of the Contract, the Buyer, among other things, appoints the Seller its attorney and agrees to sign and deliver to the Seller a power of attorney (Power of Attorney).
4. The Seller discloses to the Buyer that the Power of Attorney to be given by the Buyer to the Seller may be exercised in the following ways and purposes to enable the Seller to:
 - (a) attend at and vote in the name of the Buyer at any meetings of the Body Corporate or the Committee; or
 - (b) complete, sign and lodge any voting paper in the name of the Buyer for any meetings of the Body Corporate or the Committee; or
 - (c) complete, sign and lodge any other documents (including any proxy form, corporate owner nominee notification form, owner's representative notification form and any notice under the *Body Corporate and Community Management (Accommodation Module) Regulation 2008* (Qld) (**Regulation Module**)) to allow the Seller or attorney to vote in the name of the Buyer at all or any meetings of the Body Corporate or the Committee,

in respect of the following matters or issues:

- (d) the granting of consent to a new community management statement to be recorded to facilitate the Development;
 - (e) the granting of consent to a new community management statement to record a by-law required to rectify an inaccuracy, defect, error or omission in any by-law in Schedule C of the CMS;
 - (f) the granting of consent to a new community management statement to record allocations under any exclusive use by-law in Schedule C of the CMS or to record any new exclusive use by-law to facilitate the identification and allocation of exclusive use areas in the Scheme;
 - (g) the granting of consent to a new community management statement to record allocations under any new exclusive use by-law referred to above;
 - (h) the granting of consent to a new community management statement to record a new by-law to facilitate car parking or storage arrangements including to grant a licence for car parking or storage purposes to lot owners and occupiers;
-

- (i) the granting of consent to any appeal to be lodged in the Planning and Environment Court under the *Sustainable Planning Act 2009* (Qld) under section 60(7) of the Act, consequent upon the Local Government failing or refusing to endorse a community management statement notation on any new community management statement;
 - (j) the engagement of a person as a body corporate manager or service contractor, or authorising a person as a letting agent including the engagement of the body corporate manager under the Administration Agreement in Schedule 5 of the Disclosure Document, the engagement of a caretaker under the Caretaking Agreement in Schedule 6 of the Disclosure Document, the authorisation of a letting agent under the Caretaking Agreement in Schedule 6 of the Disclosure Document, or any amendment to any such engagement or authorisation;
 - (k) the granting of an occupation authority to a service contractor or letting agent pursuant to sections 134 or 135 of the Regulation Module to use the common property for signage, storage or maintenance purposes or any other purpose necessary to enable the service contractor to perform obligations as a service contractor or to enable the letting agent to operate as a letting agent;
 - (l) the entry into of any agreement or deed referred to in clause 9.1(a) of the Contract;
 - (m) the entry into an agreement or deed in relation to the sharing of facilities with the body corporate for an adjacent or nearby community titles scheme or with the owner of an adjacent or nearby building;
 - (n) the fixing, adoption, variation or ratification of budgets, contributions, discounts or penalties to be levied by the Body Corporate under sections 137, 138, 139, 141 and 142 of the Regulation Module;
 - (o) a proposal for a prohibition or restriction on the use of proxies;
 - (p) the granting of consent to any deed (including a deed under section 116 of the BCCM Act) or document to facilitate a transfer of a person's rights under an engagement as a service contractor or an authorisation as a letting agent with or without requiring the payment of an amount under section 124 of the Regulation Module;
 - (q) the issue of a continuing contravention notice under section 182(2) of the BCCM Act or the issue of a future contravention notice under section 183(2) of the BCCM Act;
 - (r) the issue of a notice under sections 203(1) or (2) of the BCCM Act;
 - (s) an application to be made for an order of an adjudicator under section 238 of the BCCM Act;
 - (t) an appeal to be lodged under sections 289(2) or 304 of the BCCM Act;
 - (u) the commencement of a proceeding pursuant to section 312(1) of the BCCM Act;
 - (v) any expenditure contemplated under sections 149, 150 and 151 of the Regulation Module;
 - (w) an approval for an occupier of a lot to bring or keep an animal on the lot or the common property or permit an invitee to do so;
 - (x) the issue of an authorisation to the owner of a lot (including the Original Owner) to make an improvement contemplated under sections 161, 162 and 172 of the
-

Regulation Module including the installation, erection or construction of air-conditioning equipment, enclosures, screening, shutters, security devices or apparatus and awnings;

- (y) any proposal by the Body Corporate to enter into any of the dealings permitted under sections 159, 160, 164, 165, 166 and 167 of the Regulation Module including, without limitation, the granting, amendment or surrender of any easement benefiting or burdening the Common Property or any lot as may be required by the Local Government or any other statutory authority or service provider or as may otherwise be deemed necessary or desirable by the Seller, or the granting, amendment or surrender of any lease or licence to any person over any part of the Common Property;
- (aa) the purchase or lease of any Body Corporate asset or the sale or other disposal of any Body Corporate asset;
- (bb) the transfer or incorporation of any additional land into the Scheme including the creation of additional Common Property;
- (cc) nominate a person for membership of the Committee and vote at any election of the Committee;
- (dd) intentionally deleted; and
- (ee) the convening of a general meeting of the Body Corporate or a Committee meeting to consider any one or more of the matters referred to above;
- (ff) the affixing of the seal of the Body Corporate to any document (including a Form 14 Request to record a new community management statement) to facilitate one or more of the matters referred to above;
- (gg) complete, sign and lodge any written consent as may be required to facilitate any exclusive use by-law (or any allocation or grant under it); or
- (hh) give effect to anything disclosed in the Contract or the Disclosure Document.

The Power of Attorney will be given by the Buyer to the Seller for a period expiring one year after the Scheme has been established or, in the case where the Lot exists as at the date of the contract, one year after the date of the contract or the date the Seller resigns as attorney, whichever first occurs.

Schedule 10 – Letting Agreement

BODY CORPORATE FOR PARKINSON RESIDENCES COMMUNITY
TITLES SCHEME

("BODY CORPORATE")

#####

("LETTING AGENT")

LETTING AGREEMENT

David K Lawyers
lvl 12 300 queen st
brisbane qld 4000
australia

Tel: 07 3102 2583 Fax: 07 3839 3006

**LETTING AGENT'S AGREEMENT
PARKINSON RESIDENCES COMMUNITY TITLES SCHEME**

This Agreement is made the _____ day of _____ 20 .

BETWEEN: The Body Corporate for Parkinson Residences c/- QBS Strata Management,
Level 3/ 3 Southward, Upper Coomera in the State of Queensland

("Body Corporate")

AND:

_____ of _____

("Letting Agent")

INTRODUCTION:

- A The Body Corporate has the power to grant the right to conduct the Letting Agent Business and to enter into an agreement for the provision of Letting Services.
- B The Body Corporate will grant the Letting Agent the right to conduct the Letting Agent Business, and the Letting Agent will provide the Letting Services.
- C The Parties wish to record the terms of their agreement on the following terms.

IT IS AGREED:

1. DEFINITIONS

1.1 Unless the context otherwise requires:

"Act" means the *Body Corporate and Community Management Act 1997 (Qld)*.

"Agreement" means this agreement and all its schedules.

"Associated Party" means:

- (a) in the case of a corporation, a director, secretary or shareholder of that corporation;
- (b) in the case of an individual, a corporation in which the individual is a director, secretary, or shareholder;
- (c) in the case of a partnership, the partners and management staff of the partnership.

"Body Corporate" means the Body Corporate for the Scheme.

"Body Corporate Assets" means the Body Corporate assets for the Scheme.

"Building" means any of the buildings located on the Scheme Land.

"Caretaker" means the caretaker under the Caretakers Agreement.

"Caretaker's Agreement" means the agreement entered into with the Body Corporate with the Caretaker.

"Commencement Date" means *[insert fixed date which will be settlement]*

"The Committee" means the Committee of the Body Corporate.

"Common Property" means the Common Property of the Scheme.

"Complex" means the Lots and Common Property comprised in the Scheme.

"Further Term" means fifteen (15) years commencing on the day immediately after the end of the Term.

"Letting Agent" means the Letting Agent appointed by the Body Corporate for the Scheme.

"Letting Agent Business" means:

- (a) the letting of Lots for residential tenancies;
- (b) the sale of Lots;
- (c) the hiring of equipment or items the Letting Agent considers desirable and that are not contrary to the interests of the Body Corporate and Owners and the hiring or renting of storage space (if any) comprising any part of the Letting Agent's Lot;
- (d) the provision of any other ancillary services or goods commonly provided in connection with the letting of lots in a complex of the nature of the Property and/or which the Letting Agent wishes to provide.

"Letting Agent's Lot" means that Lot in the Scheme of which the Caretaker or Associated Party is the registered proprietor (if any).

"Letting Services" means the services, duties and obligations of the Letting Agent under this Agreement.

"Lots" means lots in the Scheme.

"Nominee" means the person nominated by the Body Corporate.

"Owners" means the owners of Lots included in the Scheme and includes mortgagees in possession.

"Plan" means the Survey Plan registered for the Scheme.

"Property" means all land comprised in the Scheme and all improvements erected on the land. Where the context permits the definition extends to all adjoining land over which the Body Corporate has easement rights.

"Regulation Module" means the regulation module applying to the Scheme.

"Related Agreement" means any agreement entered into by the Letting Agent with the Body Corporate for the provision of caretaking or other services.

"Related Person" means a person or persons who are the directors or shareholders of the Letting Agent who in the reasonable opinion of the Body Corporate hold effective control of the Letting Agent.

"Representative of the Letting Agent" means:

- (a) where the Letting Agent is a corporation, its officers, managers, employees or agents; and
- (b) where the Letting Agent is an individual, his employees or agents.

"Scheme" means Parkinson Residences Community Titles Scheme.

"Scheme Land" means the Scheme land identified on the Plan.

"Term" means a period of ten (10) years from the Commencement Date.

2. INTERPRETATION

2.1 Reference to:

- (a) One gender includes the other genders.
- (b) Singular includes the plural and the plural includes the singular.
- (c) A person includes a body corporate.
- (d) A party includes the parties' executors, administrators, successors and permitted assigns.
- (e) A statute, regulation or provision of a statute or regulation ("Statutory Provision") includes:
 - (i) that Statutory Provision as amended or re-enacted from time to time; and
 - (ii) a statute, regulation or provision enacted in replacement of the Statutory Provision.
- (f) All monetary amounts are in Australian dollars, unless otherwise stated.
- (g) If a party consists of more than one person then this Agreement binds them jointly and each of them separately.
- (h) Headings are for convenience only and do not form part of this Agreement or affect its interpretation.
- (i) A party which is a trustee is bound both personally and in its capacity as a trustee.
- (j) "Including" and similar expressions are not words of limitation.

- (k) Where a word or expression is given a particular meaning, other parts of speech and grammatical forms of that word or expression have a corresponding meaning.
- (l) If an act must be done, or the last day upon which it may be done, falls on a specified day which is not a Business Day, the act must be done instead on the next Business Day.

3. APPOINTMENT AND TERM

- 3.1 The Body Corporate appoints the Letting Agent for the Term to conduct the Letting Services from the Commencement Date being the day of 20 and ending 10 years later on the day of 20 .

4. LETTING AGENT BUSINESS

- 4.1 The Body Corporate authorises the Letting Agent to conduct a Letting Agent Business for the Scheme during the Term.

5. ACKNOWLEDGEMENT

- 5.1 The Letting Agent acknowledges that Owners are free to choose whether or not they use the services of the Letting Agent or instead, use the services of some other person.

- 5.2 The Body Corporate and the Letting Agent acknowledge and agree that:

- (a) no remuneration is payable by the Body Corporate under this Agreement or is attributable or apportionable for the conducting of the Letting Agent Business or providing the Letting Services.
- (b) the Letting Agent is entitled to receive commission and/or fees for providing the Letting Agent Business or the Letting Services from such of the Owners in the Scheme. Any commission and/or fees received by the Letting Agent will be at the rate agreed between the Letting Agent and the consumer of those Letting Services.
- (c) the Body Corporate will not authorise the conduct of the Letting Services from any Lot in the Scheme other than the Letting Agent's Lot during the Term.
- (d) the Owner of a Lot may at its discretion engage persons other than the Letting Agent for the provision of Letting Services.
- (e) the Body Corporate makes no representation that Owners will appoint the Letting Agent as Letting Agent or use the Letting Agent to provide Letting Services.

- 5.3 The Body Corporate consents to the Letting Agent registering and using a business name incorporating the name of the Scheme (excluding "Community Titles Scheme") or any part of it for the Term and the Further Term.

6. LETTING AGENT'S OBLIGATIONS

- 6.1 The Letting Services may be carried out by the Letting Agent or the Representative of the Letting Agent.

6.2 The Letting Agent must conduct the Letting Agent Business and will provide the Letting Services from the Letting Agent's Lot or from any other part of the Property designated for use by the Letting Agent for that purpose.

6.3 The Letting Agent must:

- (a) offer Letting Services for the Owners who require that service;
- (b) conduct the Letting Services in a competitive manner to the standard reasonably expected of a development of this type;
- (c) use reasonable endeavours to improve and expand the letting of Lots and to act at all times to further the interests of the Body Corporate and the Owners;
- (d) obtain and comply with all necessary permits, consents or licenses required to provide the Letting Services;
- (e) if there is a Letting Agent's Lot, maintain and staff a reception area from or adjacent to the Letting Agent's Lot during such hours as reasonably necessary for the proper conduct of the Letting Services; or

If there is no Letting Agent Lot, the Letting Agent must maintain and keep open an office as a reception for the letting business during the following minimum hours:

Monday – Friday 9.00am -5.00pm; and
Saturday – 9.00am – 12noon

For the avoidance of doubt, if the Letting Agent is absent from the office during the above hours while performing its obligations under this Agreement then it will be sufficient compliance with this clause for the Letting Agent to be contactable via telephone during that time.

The Letting Agent must also be contactable by telephone or mobile phone 24/7 hours in the event of an emergency;

- (f) respond to the Body Corporate and occupants promptly
- (g) treat all Owners fairly;
- (h) not discriminate between Owners in the Scheme when letting Lots;
- (i) not give or take any secret commission;
- (j) keep proper records of all lettings and account to the Owners regularly regarding lettings and expenditure incurred in conjunction with those lettings;
- (k) accept the right of Owners to use other Letting Services and must not harass Owners in any way to obtain listings for the Letting Services;
- (l) only let a Lot for those purposes permitted by law and by the by-laws for the scheme;
- (m) supervise the standard of tenants of all lettings arranged by it and ensure so far as practicable that no nuisance is created on the Scheme Land and that the Building and Lots in the Scheme are not brought into disrepute;
- (m) to reside, or if the Letting Agent is a corporation, ensure that the person operating

the Letting Agent Business, resides in the Letting Agent's Lot (If there is one); and

- (n) keep the Letting Agent's Lot (if there is one) clean and tidy and ensure that the Letting Agent Business is open and staffed at all times during normal office hours.

7. LETTING AGENT'S CONDUCT

7.1 The Letting Agent must:

- (a) act honestly, fairly and professionally in conducting the Letting Agent Business;
- (b) exercise reasonable skill, care and diligence in conducting the Letting Agent Business;
- (c) as far as practicable, act in the best interests of the Body Corporate and individual lot owners, unless it is unlawful to do so;
- (d) take reasonable steps to ensure an employee of the Letting Agent complies with the Act, in conducting the Letting Agent Business;
- (e) not engage in fraudulent or misleading conduct in conduct in the Letting Agent Business;
- (f) not engage in unconscionable conduct in conducting the Letting Agent Business under the Letting Agent's authorisation;
- (g) not:
 - (i) cause a nuisance or hazard on Scheme Land; or
 - (ii) interfere unreasonably with the use or enjoyment of a Lot included in the Scheme; or
 - (iii) interfere unreasonably with the use or enjoyment of the Common Property by a person who is lawfully on the Common Property; or
 - (iv) otherwise behave in a way that unreasonably affects a person's lawful use or enjoyment of a Lot or Common Property.

8. BODY CORPORATE'S OBLIGATIONS

8.1 To the extent that it can lawfully so covenant, the Body Corporate will not:

- (a) itself conduct; nor
- (b) grant to any other person or entity any rights to conduct in the Complex;
a business the same or similar to the Letting Business.

8.2 To the extent that it can lawfully so covenant, the Body Corporate will:

- (a) ensure that the Common Property is cleaned and maintained to the standard of a complex of the nature as the Complex; and

- (b) co-operate with the Letting Agent in taking all action reasonably and practically necessary to stop any person or entity from conducting in the Complex a business the same or similar to the Letting Business.

9. SIGNS

- 9.1 The Letting Agent may at its own cost, erect or procure the erection of signs in or about this Scheme Land for the purpose of promoting and advertising the Letting Services. Those signs must be of a size, type and design and be placed in locations approved of in writing by the Committee.
- 9.2 Upon the expiry or termination of this Agreement the Letting Agent must remove any signs erected pursuant to this clause and restore the surfaces of the effected Scheme Land to its original condition.

10. INSTRUCTIONS

- 10.1 The Body Corporate must:
 - (a) nominate one person to communicate with the Letting Agent on its behalf; and
 - (b) notify the Letting Agent in writing of the appointment of that Nominee or its replacement.
- 10.2 The Letting Agent must:
 - (a) confer with the Nominee concerning the Letting Services; and
 - (b) attend any general meeting or Committee meeting of the Body Corporate if requested and given reasonable notice by the Nominee.

11. ASSIGNMENT

- 11.1 The Letting Agent must not assign its interest in this Agreement unless it obtains the Body Corporate's consent.
- 11.2 The Body Corporate must:
 - (a) not unreasonably, arbitrarily or capriciously refuse or delay giving its consent to any proposed assignment; and
 - (b) give its consent or refusal to any proposed assignment within 30 days of the Letting Agent giving to it the information reasonably necessary for the Body Corporate to properly consider the proposed assignment.
- 11.3 Before giving its consent to any proposed assignment, the Body Corporate will be entitled to require:
 - (a) satisfactory evidence that the proposed assignee and any Associates are financially sound and reputable, responsible, respectable and capable of satisfactorily performing the Letting Services; and
 - (b) two business references, two personal references and a bank reference of the proposed assignee and any Associates.

- 11.4 As a condition of giving its consent to any assignment, the Body Corporate will be entitled to require:
- (a) that the proposed assignee execute in favour of the Body Corporate a Deed of Covenant to comply with the terms of this Agreement;
 - (b) that the Letting Agent pay to the Body Corporate all legal costs incurred by it in giving its consent;
 - (c) if the proposed assignee is a company, other than a public company, personal guarantees from the working directors and principal shareholders; and
 - (d) that the assignee, or if it is a company, it or the Related Person become the registered owner of the Letting Agent's Lot (if applicable) and is also the assignee of rights to act as Caretaker in respect of the Scheme.
- 11.5 The Body Corporate must not require or receive any premium, payment or benefit for any request to consent or consent given under this clause, except as provided in Clause 11.4(b).

12. TERMINATION

12.1 Each of the following events constitute a default by the Letting Agent:

- (a) the Letting Agent breaches an obligation under this Agreement and in the Body Corporate's reasonable opinion:
 - (i) the non-observance can be remedied but the Letting Agent does not remedy it within 14 days after receiving written notice from the Body Corporate requiring rectification;
 - (ii) the non-observance is substantial and cannot be remedied or compensated for; or
 - (iii) the non-observance cannot be remedied but the Body Corporate can be compensated and the Letting Agent does not pay the Body Corporate compensation for the breach within 30 days after the Body Corporate gives it a notice to pay.
- (b) it becomes insolvent or is subject to a form of external administration under the Corporations Law or is subject to a sequestration order provided that if a Financier (as defined by the Body Corporate and Community Management Act 1997) or a Controller (as defined in the Corporations Act 2001) is appointed by a Financier to the Caretaker in respect of this Caretaking Agreement, the rights of the Body Corporate to terminate this Caretaking Agreement under this clause do not apply;
- (c) persistently and repeatedly breaches this Agreement materially or substantially (which shall mean at least 5 times in any one year of the Term) despite the fact that individual breaches may from time to time be remedied;
- (d) engages in misconduct or is grossly negligent in carrying out or failing to carry out obligations under this agreement;

- (e) if the Letting Agent is an individual and is convicted upon indictment of any criminal charge;
- (f) if the Letting Agent sells or transfers its interest in the Letting Agent's Lot without at the same time selling or assigning its interest in this Agreement as required by this Agreement;
- (g) if a Related Agreement is terminated;

12.2 If the Letting Agent makes default at any time the Body Corporate may at its selection by notice in writing at any time terminate this Agreement. Termination of this Agreement is without prejudice of the rights of the Body Corporate in respect of the default by the Letting Agent.

12.3 If the Body Corporate fails to perform or observe any of its obligations and duties under this Agreement within 60 days after written notice from the Letting Agent specifying the failure and requiring its rectification, the Letting Agent may by written notice terminate this Agreement.

13. AUTOMATIC TERMINATION OF LETTING AGREEMENT FOR SUBSIDIARY SCHEME

Intentionally deleted

14. FURTHER TERM

14.1 If there is not, at the time the Letting Agent gives notice under this clause nor at the end of the Term, an outstanding breach of this Agreement by the Letting Agent entitling the Body Corporate to terminate it, the Letting Agent may by giving written notice to the Body Corporate not later than 3 calendar months nor earlier than 6 calendar months prior to the expiration of the Term, extend or renew this Agreement for the Further Term, otherwise upon the same conditions as are contained in this Agreement with the exception of this clause which will be deleted.

14.2 No option may be exercised unless the option in a Related Agreement is exercised.

15. LETTING AGENT'S LOT

15.1 The Letting Agent may, or if it is a company it or its Related Person may own or otherwise have the right to occupy the Letting Agent's Lot.

15.2 If, under the previous clause the registered owner of the Letting Agent's Lot is some person or persons other than the Letting Agent, the Letting Agent must procure such person or persons to enter into a Deed of Covenant with the Body Corporate (to be prepared by the Body Corporate at the expense of the Letting Agent) to be bound by the terms of this Agreement as far as they relate to the Letting Agent's Lot.

15.3 If the Body Corporate gives its consent to an assignment of the Letting Agent's interest in this Agreement, the Letting Agent or the owner of the Letting Agent's Lot will be required to transfer the Letting Agent's Lot so that upon such assignment and transfer, there will be compliance with this Agreement.

- 15.4 Upon the termination of this Agreement, the Letting Agent will cause the transfer of the Letting Agent's Lot to the party to whom the Body Corporate enters into an agreement on terms similar to those contained in this Agreement.
- 15.5 The purchase price of the Letting Agent's Lot under this clause will be as agreed, or failing agreement as determined by a registered valuer nominated by the President of the Australian Institute of Valuers and Land Economists (Queensland Chapter). The valuer's costs will be paid by the Body Corporate except in the case of termination of this Agreement as a result of a breach by the Letting Agent, in which case the valuer's cost will be paid by the Letting Agent.
- 15.6 The terms and conditions of a sale referred to in clause 15.4 will be those contained in the standard REIQ contract applicable to the sale of strata title lots current at the time of such sale, and will provide for a 5% deposit and completion 30 days after the date of the contract.

16. CARETAKING BUSINESS

- 16.1 If the Letting Agent has entered into a Caretaking Agreement with the Body Corporate contemporaneously with entering into this Agreement, the parties acknowledge and agree that:
- (a) a default under either of the Caretaking Agreement will constitute a default under this Agreement and vice versa;
 - (b) upon the expiration or termination of the Caretaking Agreement, this Agreement will expire or terminate on the same date; and
 - (c) the Body Corporate need not give its consent to an assignment of this Agreement unless the Letting Agent assigns to the proposed assignee at the same time its interest in the Caretaking Agreements.

17. COMPLIANCE

- 17.1 The Parties agree to comply with the provisions of all statutes regulating or related to this Agreement.

18. FURTHER ASSURANCES

- 18.1 Each party must promptly or at its own cost do all things (including executing all documents) necessary or desirable to give full effect to this Agreement.

19. SEVERABILITY

- 19.1 If anything in this Agreement is unenforceable, illegal or void then it is severed and the rest of this Agreement remains in force.

20. ENTIRE UNDERSTANDING

- 20.1 This Agreement:
- (a) contains the entire Agreement and understanding between the Parties on everything connected with the subject matter of this Agreement; and
 - (b) supersedes any prior agreement or understanding or anything connected with that subject matter.

20.2 Each Party has entered into this Agreement without relying on any representation by any other Party or any person purporting to represent that Party.

21. VARIATION

21.1 An amendment or variation to this Agreement is not effective unless it is in writing and signed by the Parties.

22. WAIVER

22.1 A Party's failure or delay to exercise a power or right does not operate as a waiver of that power or right.

22.2 The exercise of a power or right does not preclude either its exercise in the further or the exercise of any other power or rights.

22.3 A waiver is not effective unless it is in writing.

22.4 Waiver of a power or right is effective only in respect of the specific instance to which it relates and for the specific purpose for which it is given.

23. COSTS AND DISBURSEMENTS

23.1 Each party must pay its own costs and disbursements connected with the negotiation, preparation and execution of this Agreement.

23.2 The Letting Agent shall pay all duties associated with this Agreement.

24. NOTICES

24.1 A notice or other communication ("Notice") connected with this Agreement has no legal effect unless it is in writing and:

- (a) delivered by hand at the address of the addressee set out in this Agreement or subsequently notified;
- (b) sent by post, postage pre-paid, to that address; or
- (c) sent by facsimile to the facsimile number of the addressee.

24.2 A Notice is deemed given and received:

- (a) if delivered, upon delivery;
- (b) if sent by post on the third Business Day (to the address to which it is posted) after posting; or
- (c) if sent by facsimile before 5.00pm on a Business Day at the place of receipt on the day it is sent or otherwise on the next Business Day at the place of receipt.

24.3 Despite the previous clause, a facsimile is not deemed given or received unless at the conclusion of the transmission the sender's facsimile machine issues a transmission report which indicates that relevant facsimile has been sent.

25. GOVERNING LAW AND JURISDICTION

25.1 The law of Queensland governs this Agreement.

25.2 The parties submit to the non-exclusive jurisdiction of the courts of Queensland and consent to all claims and disputes in relation to this Agreement being instituted in the central Brisbane jurisdiction.

Executed as an Agreement the _____ day of

20 .

The Common Seal of Parkinson Residences
Community Titles Scheme was affixed this
day of 20]
in the presence of:]

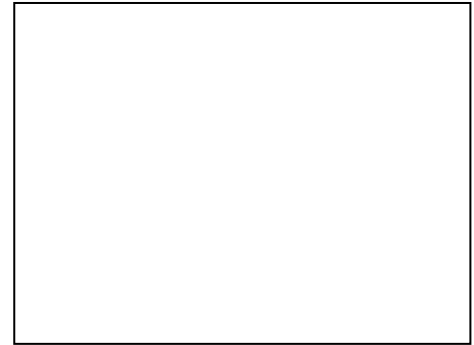

A witness

Full name of witness

Chairman

Signed Sealed and delivered by]
the Letting Agent]
the _____ day of 20]
in the presence of]



A witness

Full name of witness

Schedule 11 – Development Plans

| DEVELOPMENT SUMMARY | |
|----------------------------------|---------------------------|
| SITE AREA | 10476m² |
| 4 Bed double garage | 29 |
| 3 Bed double garage | 0 |
| 3 Bed single garage | 0 |
| Total Townhomes | 29 |
| Visitor accommodation | |
| Visitor Parks..... | 7 |
| Tandem Parks..... | 10 |
| Resident Parks..... | 58 |
| Total Vehicle Parks | 75 |

| TOWNHOMES DWELLINGS | BLOCKS | UNITS |
|-----------------------------|-----------|-----------|
| 2 STOREY - DUAL OCCUPANCY | 3 | 6 |
| 2 STOREY - TRIPLE OCCUPANCY | 5 | 15 |
| 2 STOREY - QUAD OCCUPANCY | 2 | 8 |
| 2 STOREY - QUINT OCCUPANCY | 0 | 0 |
| 2 STOREY - SEXT OCCUPANCY | 0 | 0 |
| 3 STOREY - DUAL OCCUPANCY | 0 | 0 |
| 3 STOREY - TRIPLE OCCUPANCY | 0 | 0 |
| 3 STOREY - QUAD OCCUPANCY | 0 | 0 |
| TOTAL BLOCKS | 10 | 29 |

| SITE CALCULATIONS: | |
|------------------------------|--------------------------|
| GFA: | 3541m ² (34%) |
| SITE COVER: | 2403m ² (23%) |
| OPEN SPACE SUMMARY | |
| Public Open Space..... | 3332m ² (32%) |
| Private Courtyard Space..... | 1273m ² (12%) |

| TYPE A = | 15 |
|----------|----|
| TYPE B = | 14 |

| KEY LEGEND | |
|------------|---------------------------------|
| VP 1 | Visitor Park (5400 x 2600) |
| TP 1 | Tandem Park (5400 x 2600) |
| | PRIVATE COURTYARD |
| | COMMUNAL OPEN SPACE |
| | LANDSCAPE BUFFER RETAINING WALL |
| | ACoustic FENCE |
| | TPZ OF TREES TO BE RETAINED |

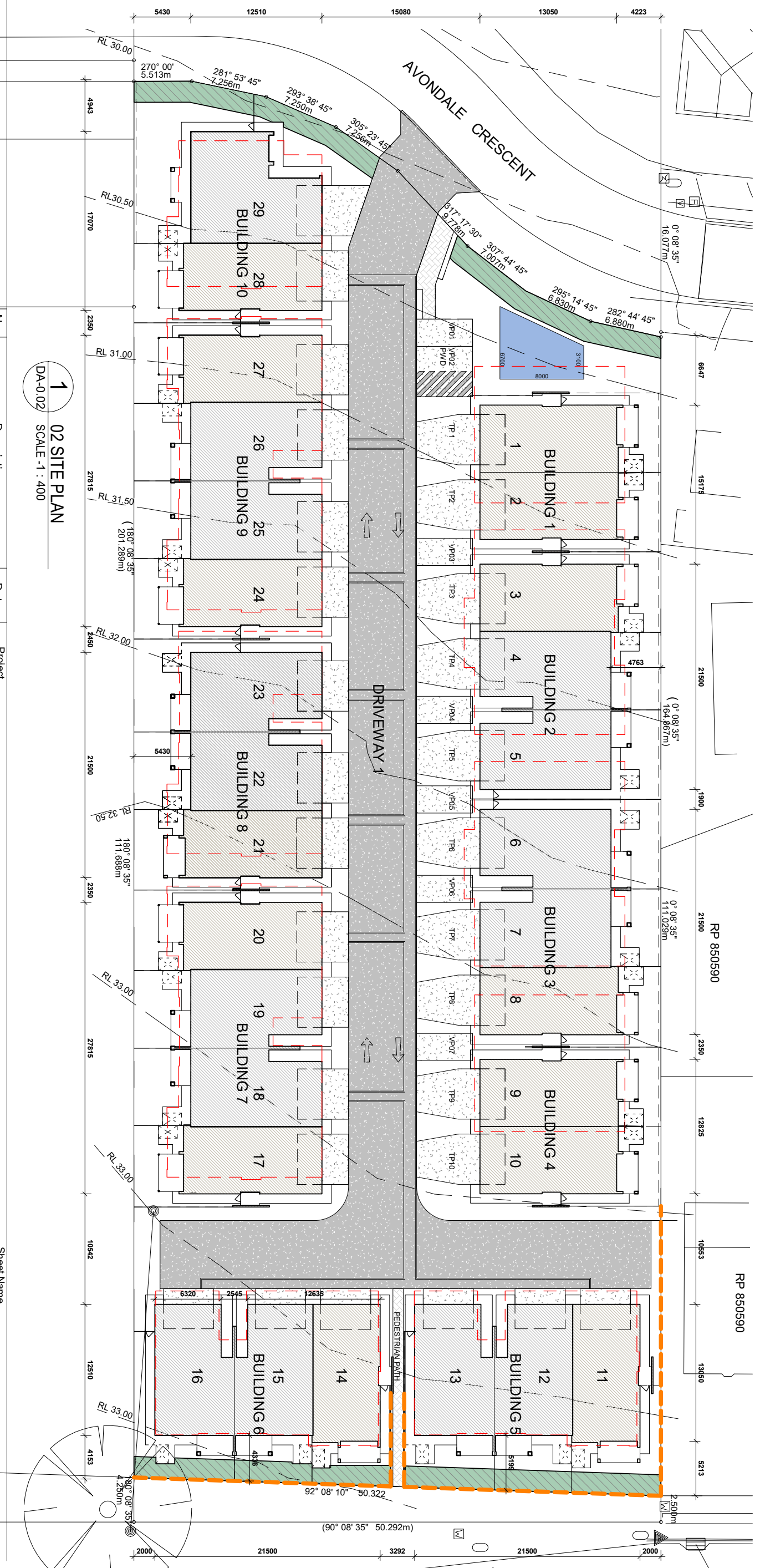

1 02 SITE PLAN
DA-0.02 SCALE - 1 : 400

| No. | Description | Date |
|-----|----------------------------|----------|
| 1 | ISSUE FOR MINOR CHANGE | 24.07.20 |
| 2 | UPDATE PEDESTRIAN PATH | 31.07.20 |
| 3 | MINOR ADJUSTMENT TO SETOUT | 04.08.20 |

PROPOSED TOWNHOUSE DEVELOPMENT
 Location
 200 NOTTINGHAM RD, PARKINSON
 Client
 HIGHWAY DEVELOPMENTS No1 PTY LTD

Sheet Name
SITE PLAN
 Scale
As Indicated
 Project Number
0000
 Drawn by
TB
 Drawing Number
DA-0.02
 Date
22.07.2020
 Revision
3

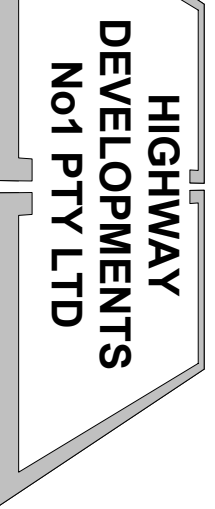
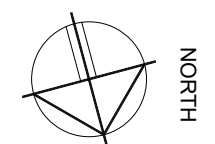

SiteTown House Development_CurrentNottingham Rd 200, PARKINSON-0A-ARCHITECTURAL PACKAGE_040820.rvt

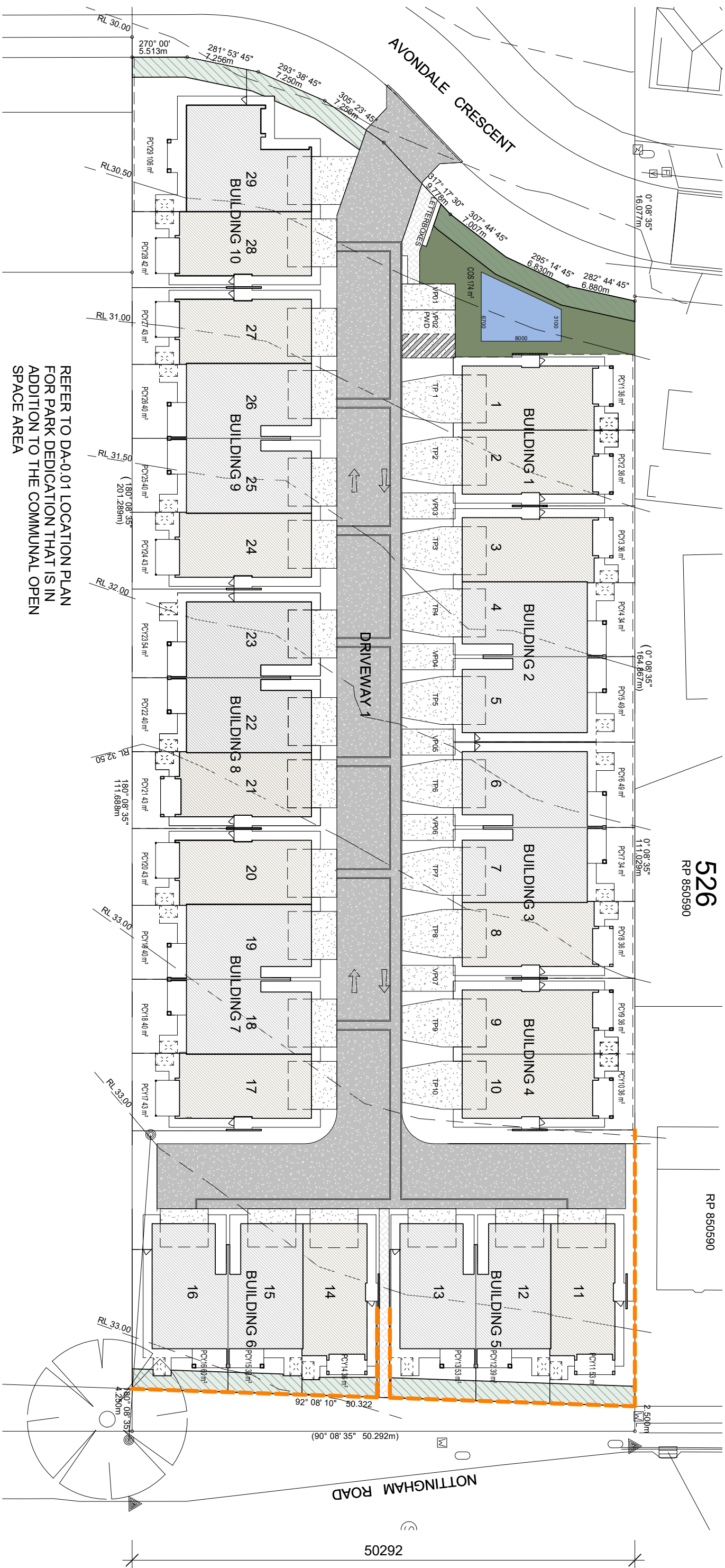

REFER TO DA-0.01 LOCATION PLAN FOR PARK DEDICATION THAT IS IN ADDITION TO THE COMMUNAL OPEN SPACE AREA

526
RP 850590

RP 850590

50292

HIGHWAY DEVELOPMENTS No1 PTY LTD

| No. | Description | Date |
|-----|----------------------------|----------|
| 1 | ISSUE FOR MINOR CHANGE | 24.07.20 |
| 2 | UPDATE PEDESTRIAN PATH | 31.07.20 |
| 3 | MINOR ADJUSTMENT TO SETOUT | 04.08.20 |

Project
PROPOSED TOWNHOUSE DEVELOPMENT
 Location
 200 NOTTINGHAM RD, PARKINSON
 Client
 HIGHWAY DEVELOPMENTS No1 PTY LTD

Sheet Name
COMMUNAL OPEN SPACE
 Scale
 1 : 400
 Project Number
 0000
 Drawing Number
 DA-0.03
 Date
 22.07.2020
 Revision
 3

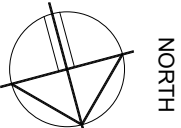

| PRIVATE COURTYARD SPACE | | PRIVATE COURTYARD SPACE | |
|-------------------------|-------------------|-------------------------|---------------------|
| PCY1 | 36 m ² | PCY17 | 43 m ² |
| PCY2 | 36 m ² | PCY18 | 40 m ² |
| PCY3 | 36 m ² | PCY19 | 40 m ² |
| PCY4 | 34 m ² | PCY20 | 43 m ² |
| PCY5 | 49 m ² | PCY21 | 43 m ² |
| PCY6 | 49 m ² | PCY22 | 40 m ² |
| PCY7 | 34 m ² | PCY23 | 54 m ² |
| PCY8 | 36 m ² | PCY24 | 43 m ² |
| PCY9 | 36 m ² | PCY25 | 40 m ² |
| PCY10 | 36 m ² | PCY26 | 40 m ² |
| PCY11 | 53 m ² | PCY27 | 43 m ² |
| PCY12 | 53 m ² | PCY28 | 42 m ² |
| PCY13 | 53 m ² | PCY29 | 1273 m ² |
| PCY14 | 36 m ² | | |
| PCY15 | 33 m ² | | |
| PCY16 | 60 m ² | | |











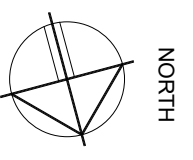

HIGHWAY DEVELOPMENTS No1 PTY LTD

| No. | Description | Date |
|-----|----------------------------|----------|
| 1 | ISSUE FOR MINOR CHANGE | 24.07.20 |
| 2 | UPDATE PEDESTRIAN PATH | 31.07.20 |
| 3 | MINOR ADJUSTMENT TO SETOUT | 04.08.20 |

Project
PROPOSED TOWNHOUSE DEVELOPMENT
 Location
 200 NOTTINGHAM RD, PARKINSON
 Client
 HIGHWAY DEVELOPMENTS No1 PTY LTD

Sheet Name
PRIVATE OPEN SPACE
 Scale
 1 : 400
 Project Number
 0000
 Drawing Number
 DA-0.04
 Date
 22.07.2020
 Revision
 3



| STAGING LEGEND | |
|---|-----------------------------------|
|  | Park & Nottingham Road dedication |
|  | STAGE 1 Avondale Cr extension |
|  | 16 Dwelling units |
|  | 32 Resident car spaces |
|  | 5 Visitor car spaces |
|  | STAGE 2 |
|  | 13 Dwelling units |
|  | 26 Resident car spaces |
|  | 2 Visitor car spaces |
|  | 10 Tandem parking spaces |

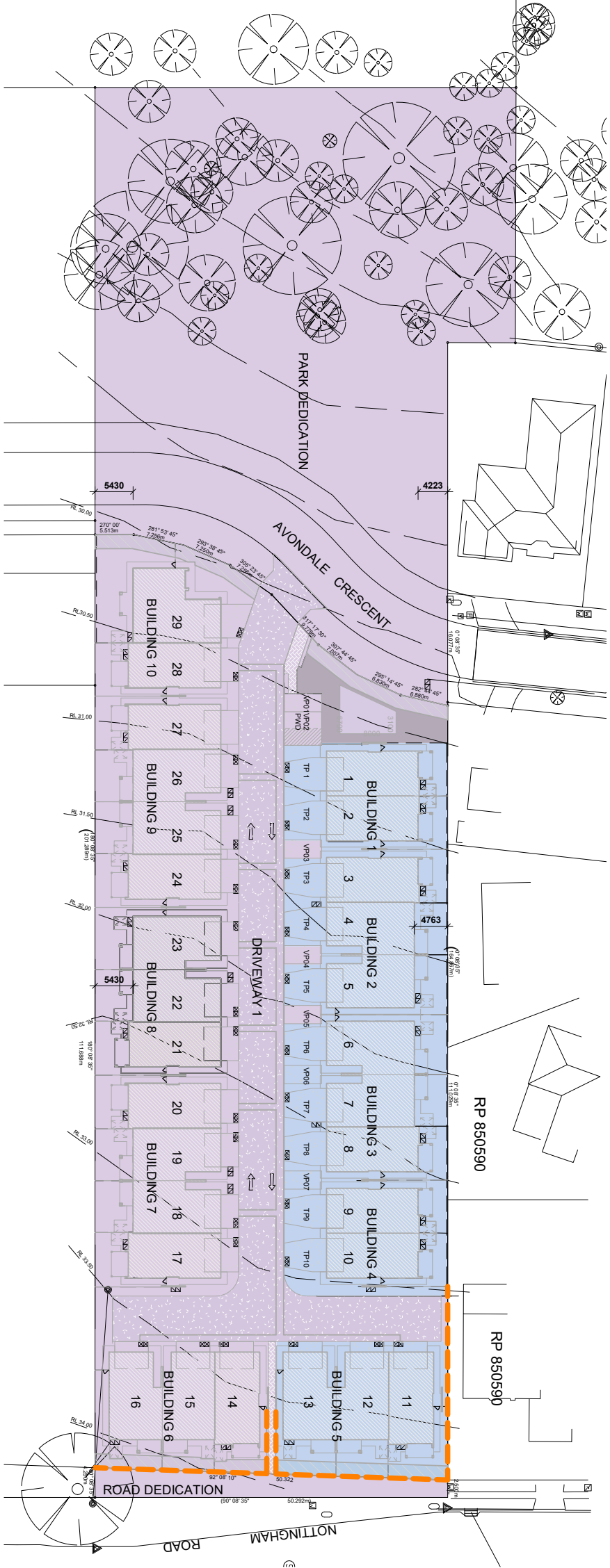

| No. | Description | Date |
|-----|----------------------------|----------|
| 1 | ISSUE FOR MINOR CHANGE | 24.07.20 |
| 2 | UPDATE PEDESTRIAN PATH | 31.07.20 |
| 3 | MINOR ADJUSTMENT TO SETOUT | 04.08.20 |

| Project | | Sheet Name | |
|--|--|---------------------------|--|
| PROPOSED TOWNHOUSE DEVELOPMENT | | STAGING PLAN | |
| Location 200 NOTTINGHAM RD, PARKINSON | | Scale 1 : 750 | |
| Client HIGHWAY DEVELOPMENTS No1 PTY LTD | | Drawn by TB | |
| | | Project Number 0000 | |
| | | Drawing Number DA-0.05 | |
| | | Date 22.07.2020 | |
| | | Revision 3 | |

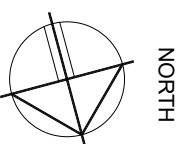

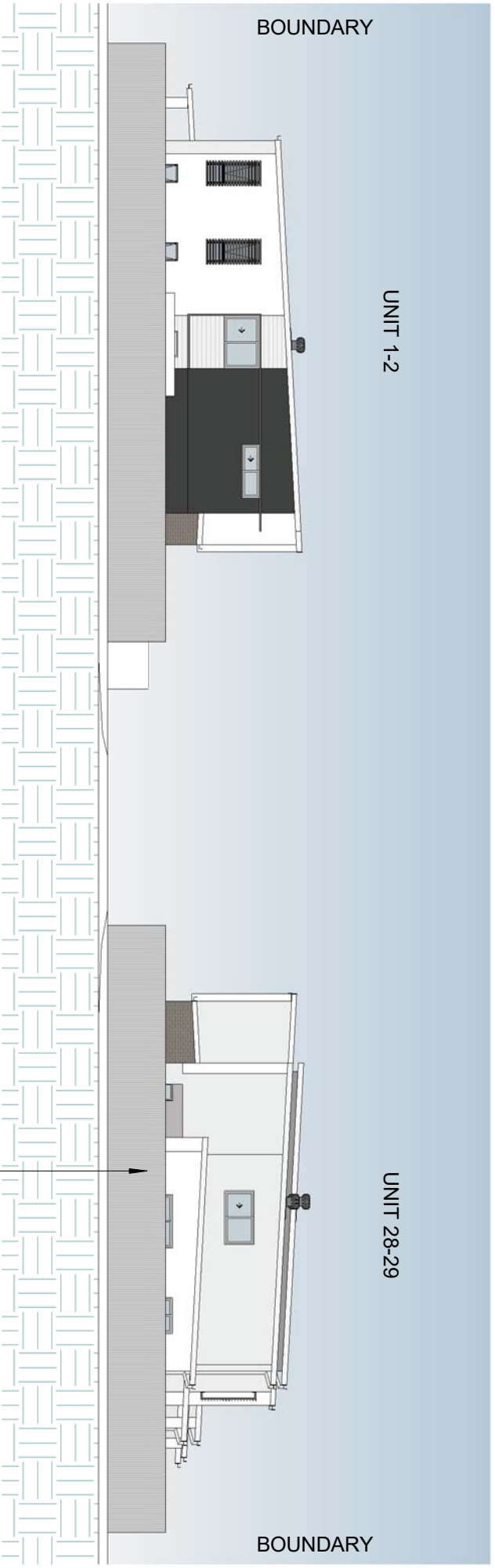

1
1/200 EXTERNAL SOUTH - AVONDALE CR
1 : 200

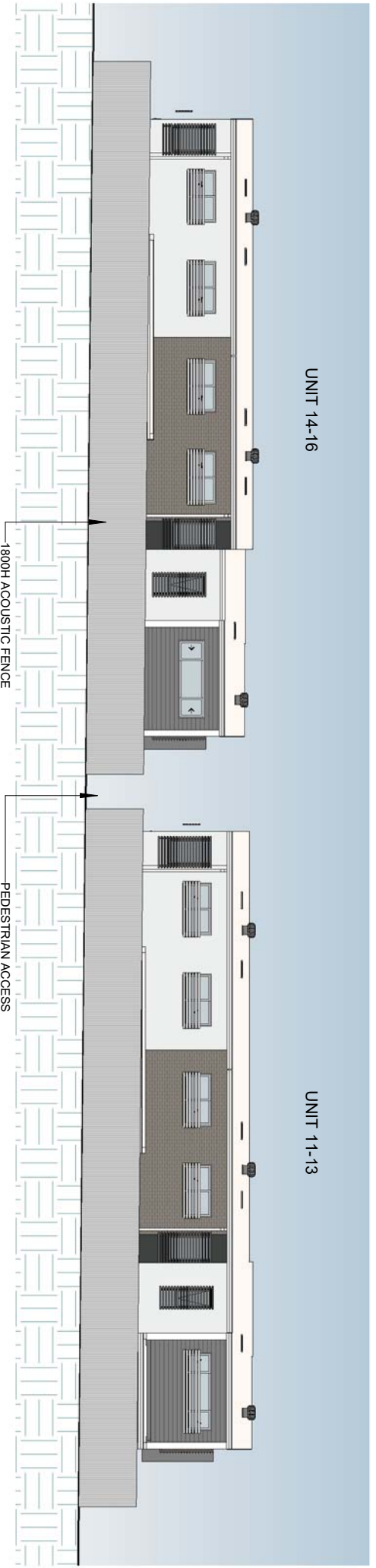

2
NOTTINGHAM RD
1 : 200

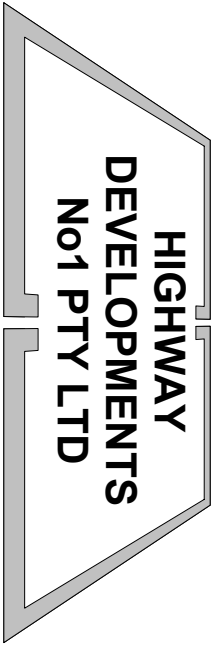

| No. | Description | Date |
|-----|----------------------------|----------|
| 1 | ISSUE FOR MINOR CHANGE | 24.07.20 |
| 2 | UPDATE PEDESTRIAN PATH | 31.07.20 |
| 3 | MINOR ADJUSTMENT TO SETOUT | 04.08.20 |
| | | |
| | | |

Project
PROPOSED TOWNHOUSE DEVELOPMENT
Location
200 NOTTINGHAM RD, PARKINSON
Client
HIGHWAY DEVELOPMENTS No1 PTY LTD

S:\Town House Development_Current\Nottingham Rd 200, PARKINSON05 - 0A\ARCHITECTURAL PACKAGE_040820.rvt

Sheet Name
EXTERNAL STREETSCAPE

Scale
1 : 200

Drawn by
TB

Date
22.07.2020

Project Number
0000

Drawing Number
DA-1.01

Revision
3

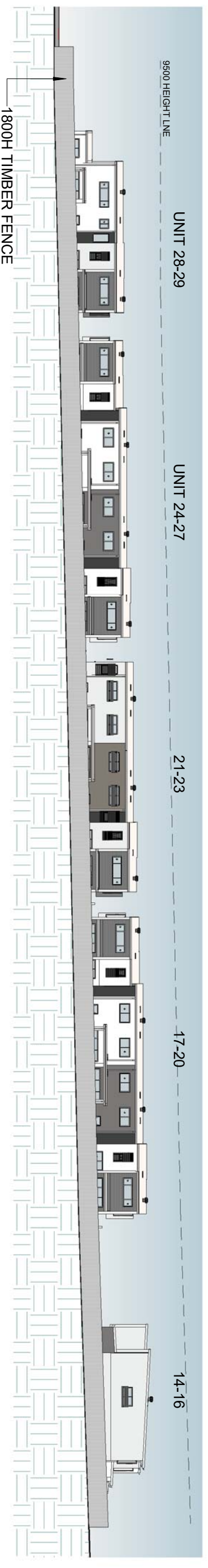

1
EXTERNAL - EAST

1 : 400

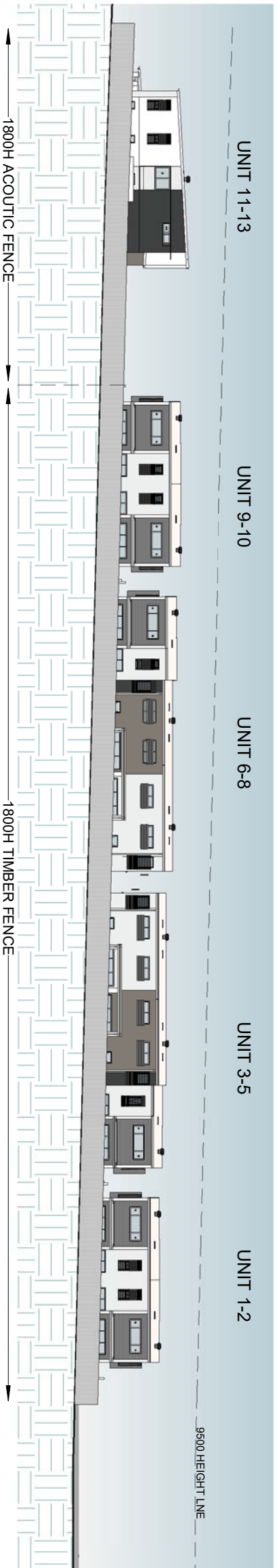

2
EXTERNAL - WEST

1 : 400

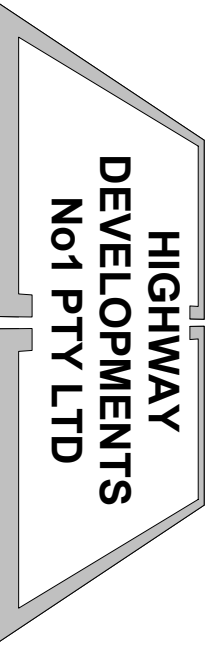

| No. | Description | Date |
|-----|----------------------------|----------|
| 2 | UPDATE PEDESTRIAN PATH | 31.07.20 |
| 3 | MINOR ADJUSTMENT TO SETOUT | 04.08.20 |
| | | |
| | | |
| | | |

| Project | | Sheet Name | |
|--|--|------------------------|---------------------------|
| PROPOSED TOWNHOUSE DEVELOPMENT | | EXTERNAL ELEVATIONS | |
| Location 200 NOTTINGHAM RD, PARKINSON | | Scale 1 : 400 | Drawn by TB |
| Client HIGHWAY DEVELOPMENTS No1 PTY LTD | | Project Number 0000 | Drawing Number DA-1.02 |
| | | | Date 22.07.2020 |
| | | | Revision 3 |



1
1/400 INTERNAL EAST
1 : 400



2
1/400 INTERNAL WEST
1 : 400



3
1/200 INTERNAL SOUTH
1 : 400

| No. | Description | Date |
|-----|----------------------------|----------|
| 1 | ISSUE FOR MINOR CHANGE | 24.07.20 |
| 2 | UPDATE PEDESTRIAN PATH | 31.07.20 |
| 3 | MINOR ADJUSTMENT TO SETOUT | 04.08.20 |
| | | |
| | | |
| | | |



| Project | | Sheet Name | |
|---|--|-------------------------------|----------------------------------|
| PROPOSED TOWNHOUSE DEVELOPMENT | | INTERNAL STREETSCAPE | |
| Location 200 NOTTINGHAM RD, PARKINSON | | Scale 1 : 400 | Drawn by TB |
| Client HIGHWAY DEVELOPMENTS No1 PTY LTD | | Project Number 0000 | Drawing Number DA-1.03 |
| | | | Revision 3 |
| | | | Date 22.07.2020 |

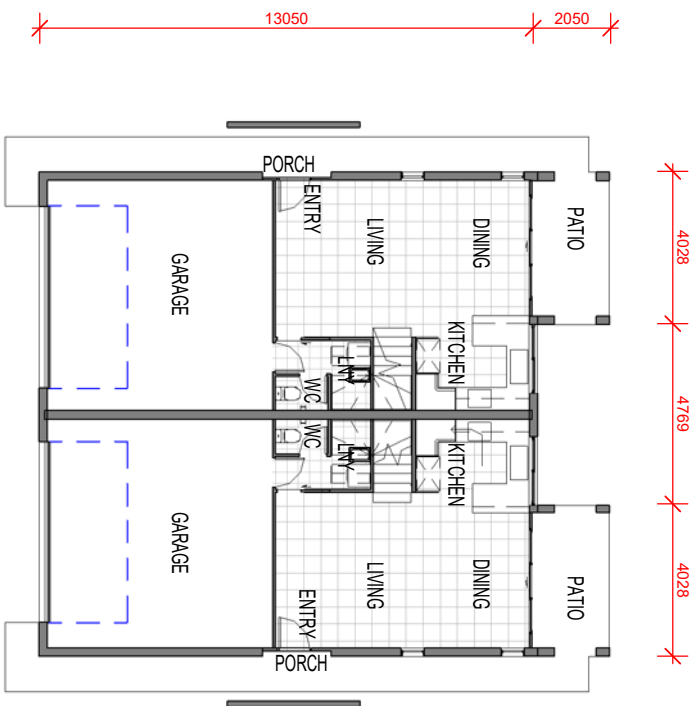

1 GROUND FLOOR PLAN (1-200)
DA-2.01 SCALE - 1 : 200

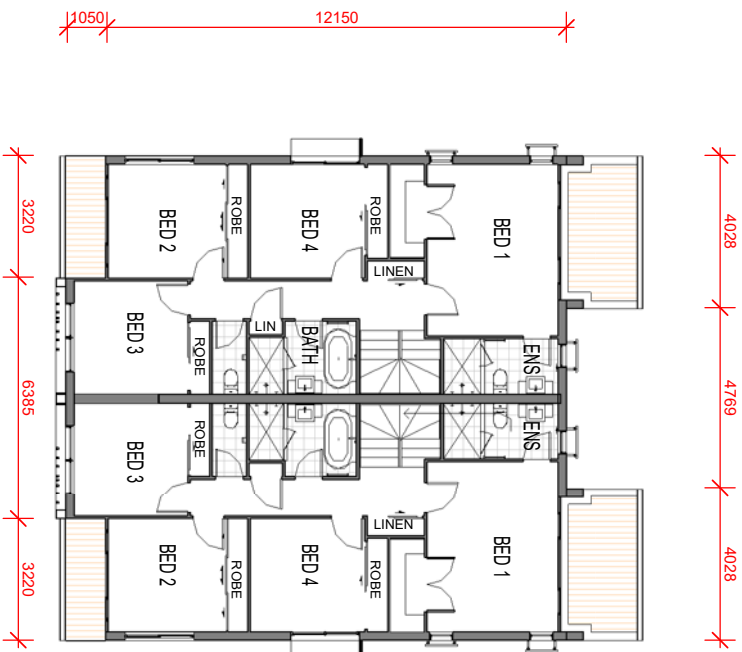

2 FIRST FLOOR PLAN (1-200)
DA-2.01 SCALE - 1 : 200

GFA 237.7m²
Site Cover 184.0 m²

EXTERNAL FINISHES

| | |
|-----|---|
| F01 | FACE BRICKWORK (AS SELECTED) |
| F02 | BRICKWORK WITH TEXTURE FINISH |
| F03 | BRICKWORK WITH RENDER FINISH (COLOUR 1) |
| F04 | BRICKWORK WITH RENDER FINISH (COLOUR 2) |
| F14 | HARDIES LINEA BOARDING |
| F36 | VERTICAL ALUMINIUM SCREEN |

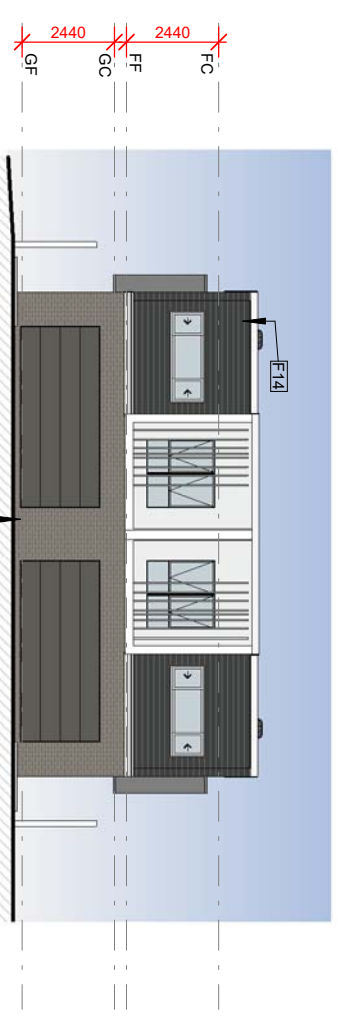

3 1/200 FRONT ELEVATION
DA-2.01 SCALE - 1 : 200

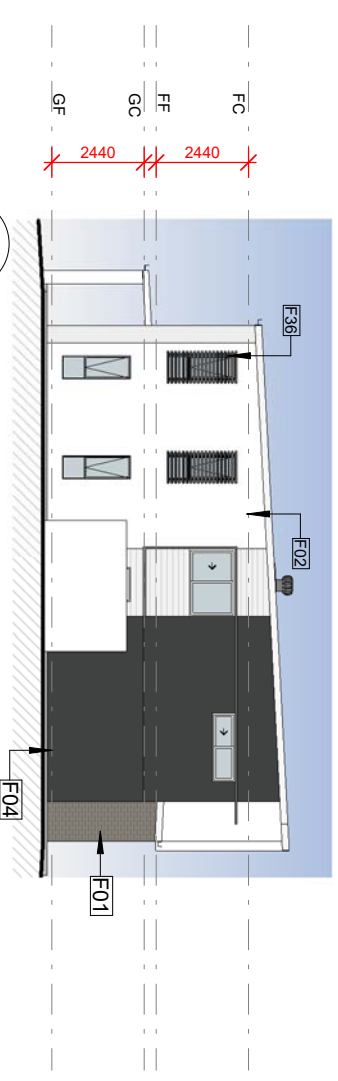

4 1/200 LEFT ELEVATION
DA-2.01 SCALE - 1 : 200



5 1/200 RIGHT ELEVATION
DA-2.01 SCALE - 1 : 200



6 1/200 REAR ELEVATION
DA-2.01 SCALE - 1 : 200

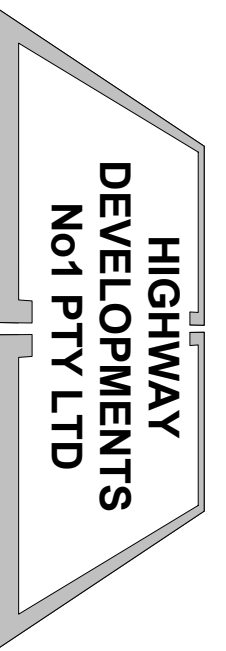

| No. | Description | Date |
|-----|--------------|----------|
| 1 | MINOR CHANGE | 24.07.20 |
| 2 | AMEND PATIO | 04.08.20 |
| | | |
| | | |
| | | |
| | | |

| Project | | Unit Type | | Sheet Name | |
|--|--|---|--|---------------------------|--|
| MULTIPLE DWELLING UNITS | | TYPE A DUPLEX | | DA SHEET | |
| Location 200 NOTTINGHAM RD, PARKINSON | | Unit Number BUILDING 1 & 4 - UNIT 1-2 & 9-10 | | Scale 1 : 200 | |
| Client HIGHWAY DEVELOPMENTS No1 PTY LTD | | Project Number 0000 | | Drawing Number DA-2.01 | |
| | | | | Drawn by TB | |
| | | | | Date JULY 2020 | |
| | | | | Revision 2 | |

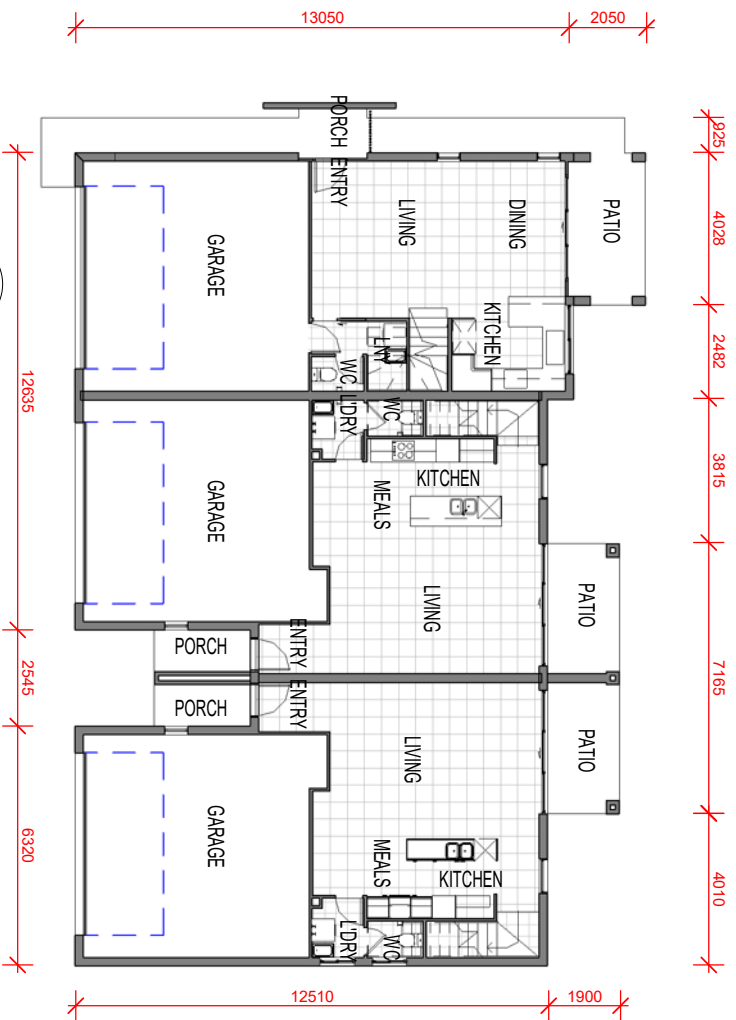

1 GROUND FLOOR PLAN (1-200)
DA-2.02 SCALE - 1 : 200

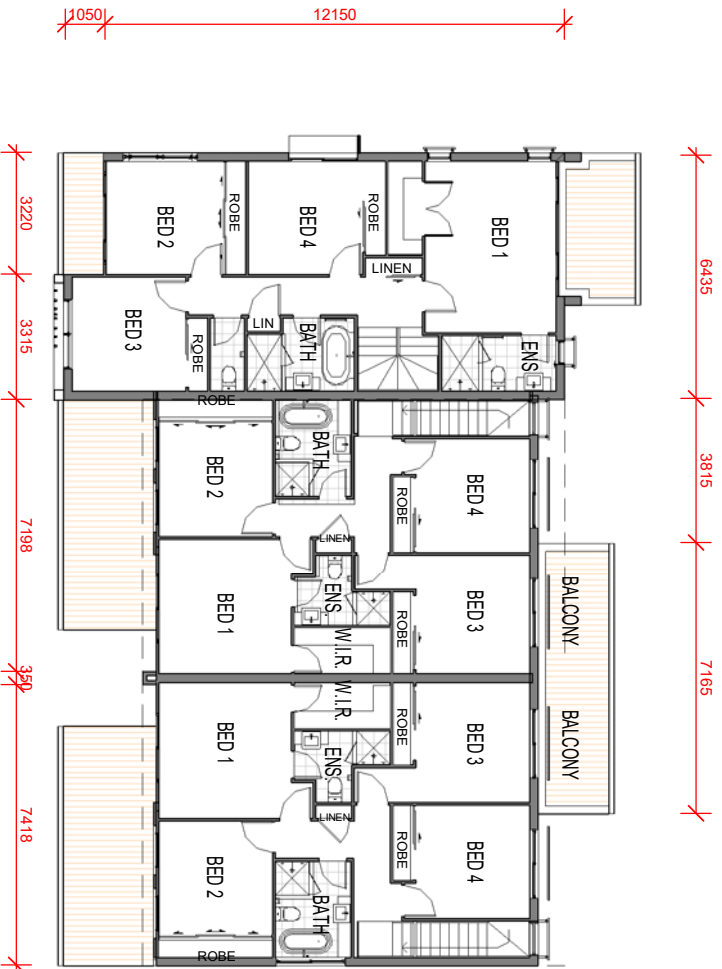

2 FIRST FLOOR PLAN (1-200)
DA-2.02 SCALE - 1 : 200



3 1/200 FRONT ELEVATION
DA-2.02 SCALE - 1 : 200

GFA 372.5 m²
Site Cover 305.5 m²

EXTERNAL FINISHES

| | |
|-----|---|
| F01 | FACE BRICKWORK (AS SELECTED) |
| F03 | BRICKWORK WITH RENDER FINISH (COLOUR 1) |
| F04 | BRICKWORK WITH RENDER FINISH (COLOUR 2) |
| F09 | SCYON AXON CLADDING |
| F10 | SCYON MATRIX CLADDING |
| F14 | HARDIES LINEA BOARDING |
| F22 | COLORBOND TRIMDEK METAL ROOF SHEETING (AS SELECTED) |



4 1/200 LEFT ELEVATION
DA-2.02 SCALE - 1 : 200

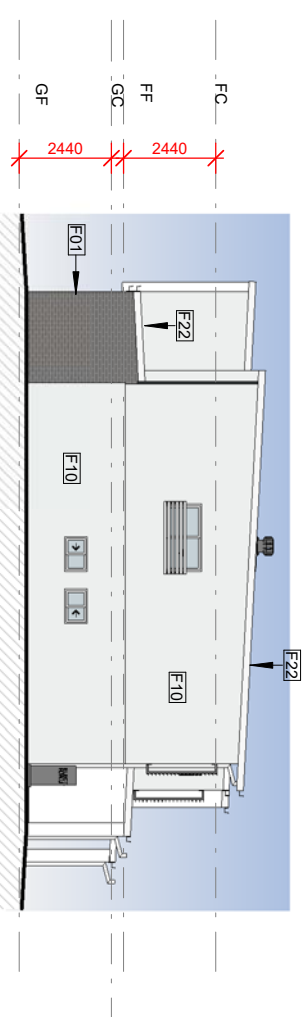

5 1/200 RIGHT ELEVATION
DA-2.02 SCALE - 1 : 200



6 1/200 REAR ELEVATION
DA-2.02 SCALE - 1 : 200

HIGHWAY DEVELOPMENTS No1 PTY LTD

| No. | Description | Date |
|-----|--------------|----------|
| 1 | MINOR CHANGE | 24.07.20 |
| 2 | AMEND PATIOS | 04.08.20 |

| Project | Unit Type | Sheet Name |
|--|--|-------------------|
| MULTIPLE DWELLING UNITS | TYPE A & B TRIPLEX | DA SHEET |
| Location 200 NOTTINGHAM RD, PARKINSON | Unit Number BUILDING 2 & 6 - UNIT 3-5 & 14-16 | Scale 1 : 200 |
| Client HIGHWAY DEVELOPMENTS No1 PTY LTD | Project Number 0000 | Drawn by TB |
| | | Date JULY 2020 |
| | | Revision 2 |

S:\Town House Development_Current\Nottingham Rd 200, PARKINSON\05 - 06\BUILDINGS\WESTPORT EASTPORT TRIPLEX.dwg

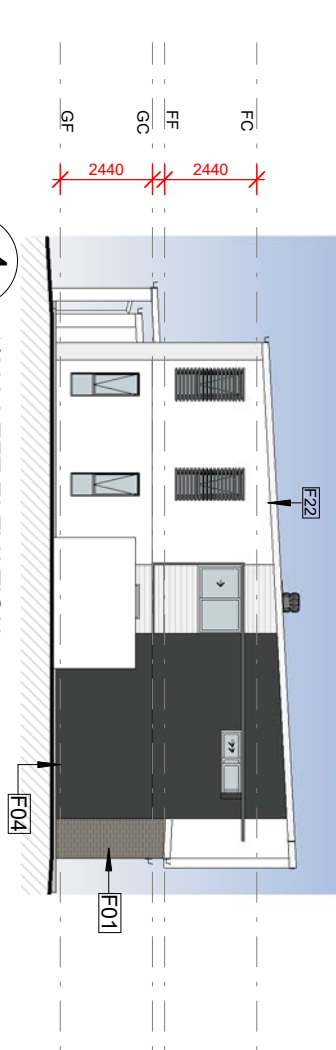
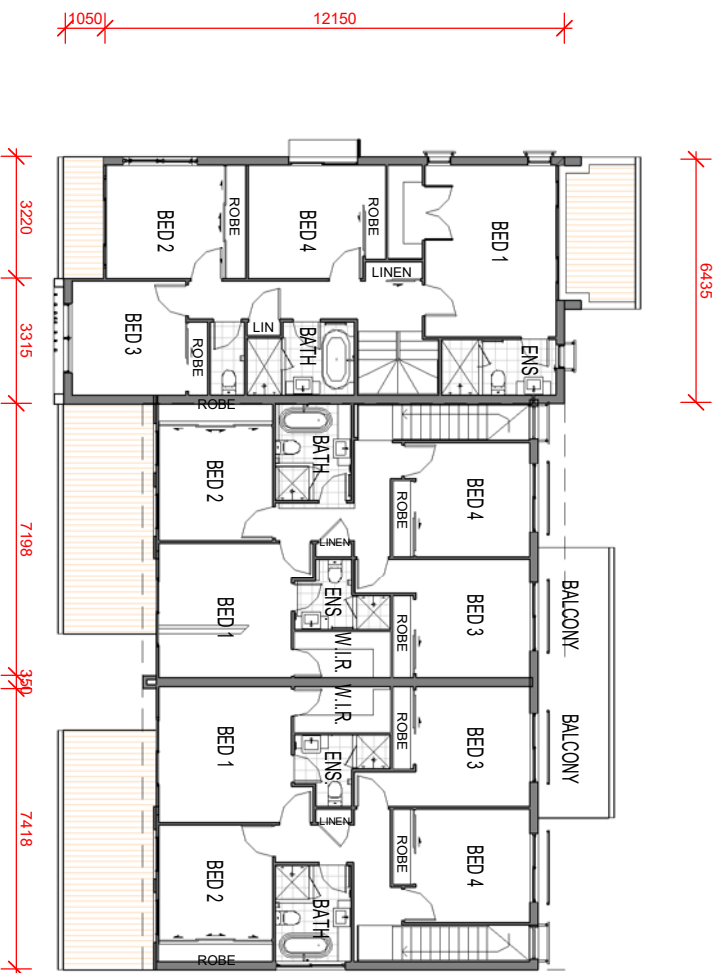
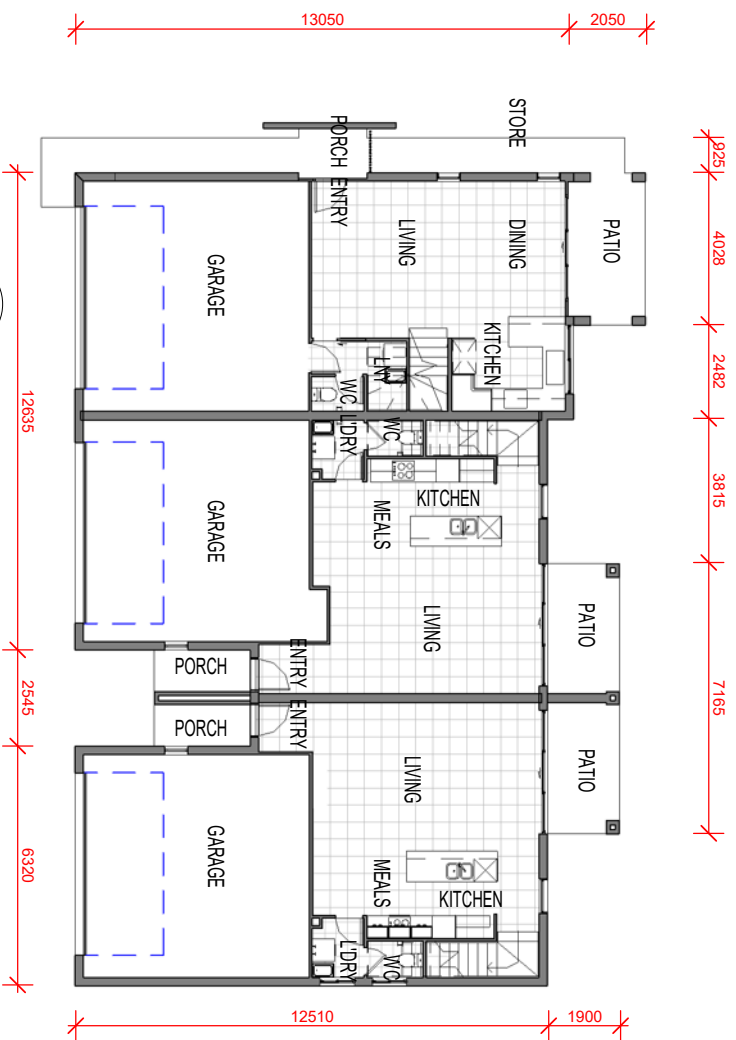

EXTERNAL FINISHES

| | |
|-----|---|
| F01 | FACE BRICKWORK (AS SELECTED) |
| F03 | BRICKWORK WITH RENDER FINISH (COLOUR 1) |
| F04 | BRICKWORK WITH RENDER FINISH (COLOUR 2) |
| F09 | SCYON AXON CLADDING |
| F10 | SCYON MATRIX CLADDING |
| F14 | HARDIES LINEA BOARDING |
| F22 | COLORBOND TRIMDEK METAL ROOF SHEETING (AS SELECTED) |

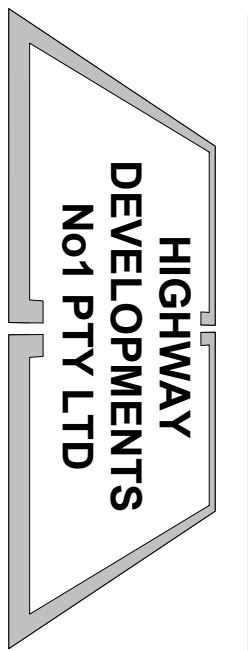
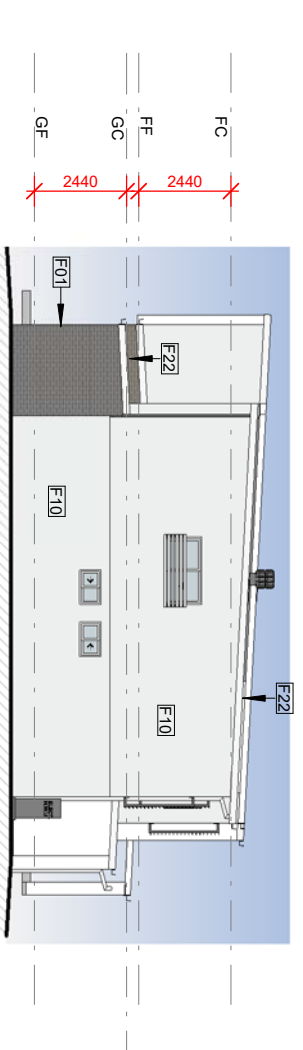

| No. | Description | Date |
|-----|--------------|----------|
| 1 | MINOR CHANGE | 24.07.20 |
| 2 | AMEND PATIOS | 04.08.20 |

| Project | | Unit Type | | Sheet Name | |
|--|--|--|--|-------------------|--|
| MULTIPLE DWELLING UNITS | | TYPE A & B TRIPLEX | | DA SHEET | |
| Location 200 NOTTINGHAM RD, PARKINSON | | Unit Number BUILDING 3 & 8 - UNIT 6-8 & 21-23 | | Scale 1 : 200 | |
| Client HIGHWAY DEVELOPMENTS No1 PTY LTD | | Project Number 0000 | | Drawn by TB | |
| | | | | Date JULY 2020 | |
| | | | | Revision 2 | |

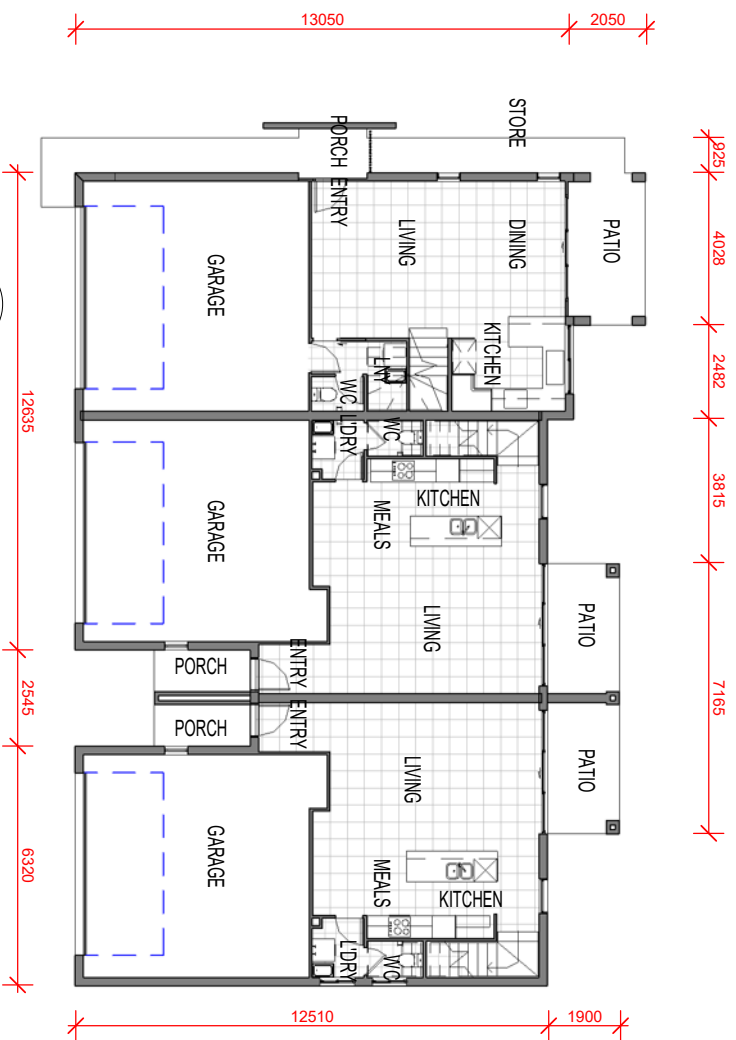

1 GROUND FLOOR PLAN (1-200)
DA-2.04 SCALE - 1 : 200

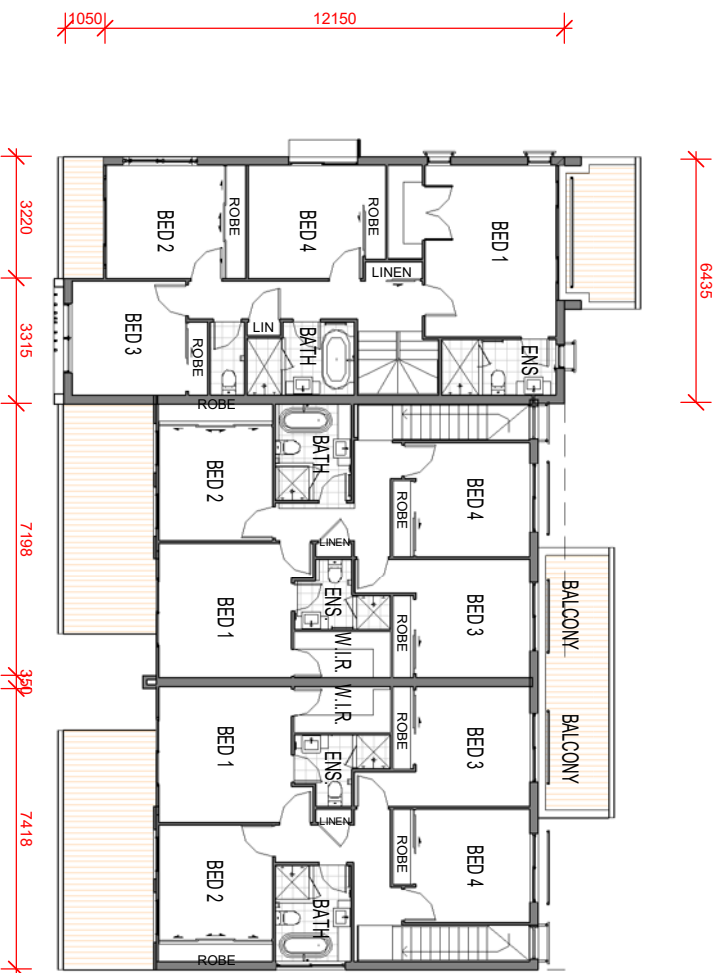

2 FIRST FLOOR PLAN (1-200)
DA-2.04 SCALE - 1 : 200

GFA 372.5 m²
Site Cover 305.5 m²

| EXTERNAL FINISHES | |
|-------------------|---|
| F01 | FACE BRICKWORK (AS SELECTED) |
| F03 | BRICKWORK WITH RENDER FINISH (COLOUR 1) |
| F04 | BRICKWORK WITH RENDER FINISH (COLOUR 2) |
| F09 | SCYON AXON CLADDING |
| F10 | SCYON MATRIX CLADDING |
| F14 | HARDIES LINEA BOARDING |
| F22 | COLORBOND TRIMDEK METAL ROOF SHEETING (AS SELECTED) |

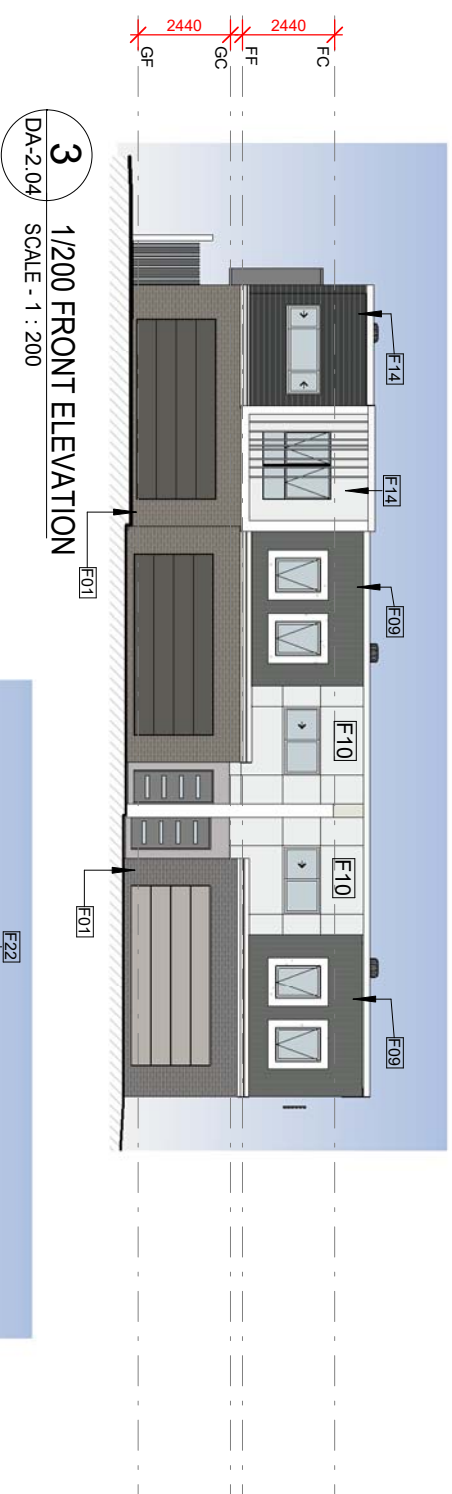

3 1/200 FRONT ELEVATION
DA-2.04 SCALE - 1 : 200



4 1/200 LEFT ELEVATION
DA-2.04 SCALE - 1 : 200

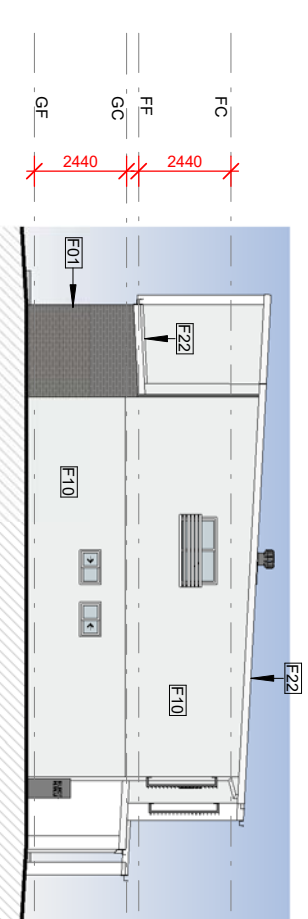

5 1/200 RIGHT ELEVATION
DA-2.04 SCALE - 1 : 200



6 1/200 REAR ELEVATION
DA-2.04 SCALE - 1 : 200

| No. | Description | Date |
|-----|------------------------|----------|
| 1 | ISSUE FOR MINOR CHANGE | 24.07.20 |
| 2 | AMEND PATIOS | 04.08.20 |

HIGHWAY DEVELOPMENTS
No1 PTY LTD

| Project | Unit Type | Sheet Name |
|--|--|-------------------|
| MULTIPLE DWELLING UNITS | TYPE A & B TRIPLEX | DA SHEET |
| Location 200 NOTTINGHAM RD, PARKINSON | Unit Number BUILDING 5 - UNIT 11-13 | Scale 1 : 200 |
| Client HIGHWAY DEVELOPMENTS No1 PTY LTD | Project Number 0000 | Drawn by TB |
| | | Date JULY 2020 |
| | | Revision 2 |

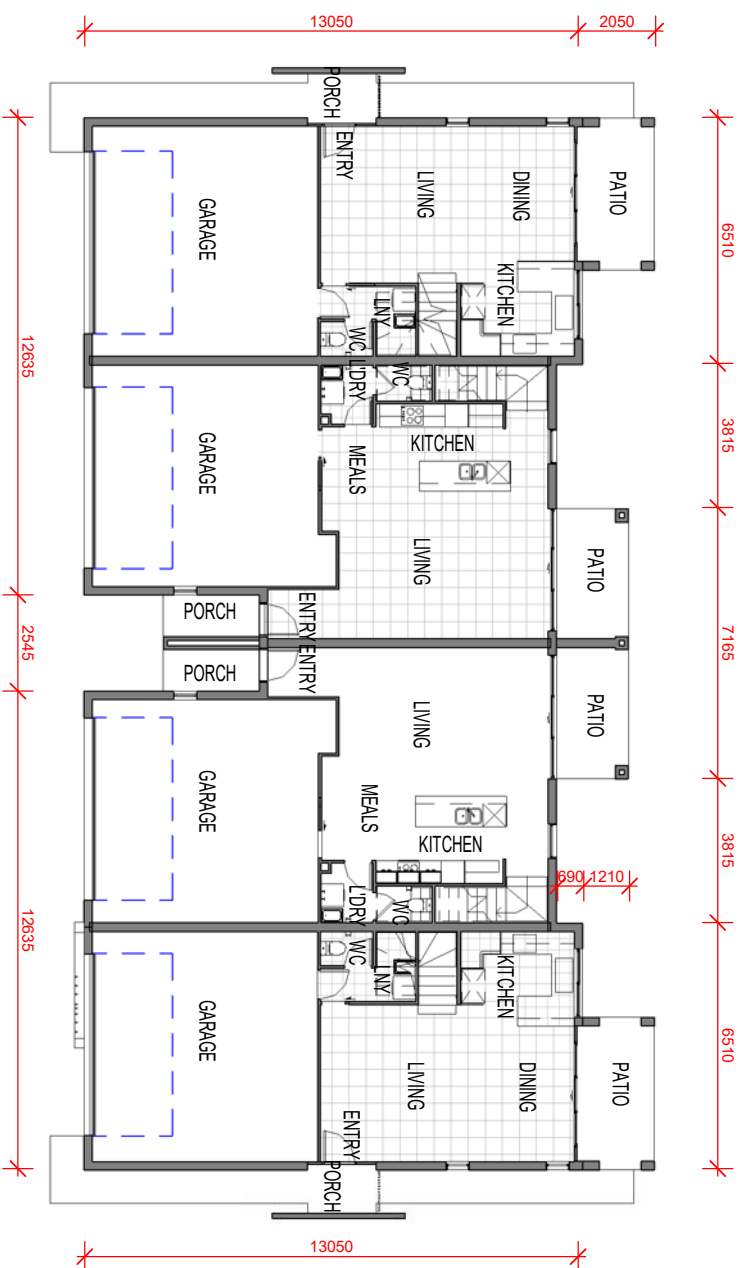

1 GROUND FLOOR PLAN (1-200)
DA-2.05 SCALE - 1 : 200

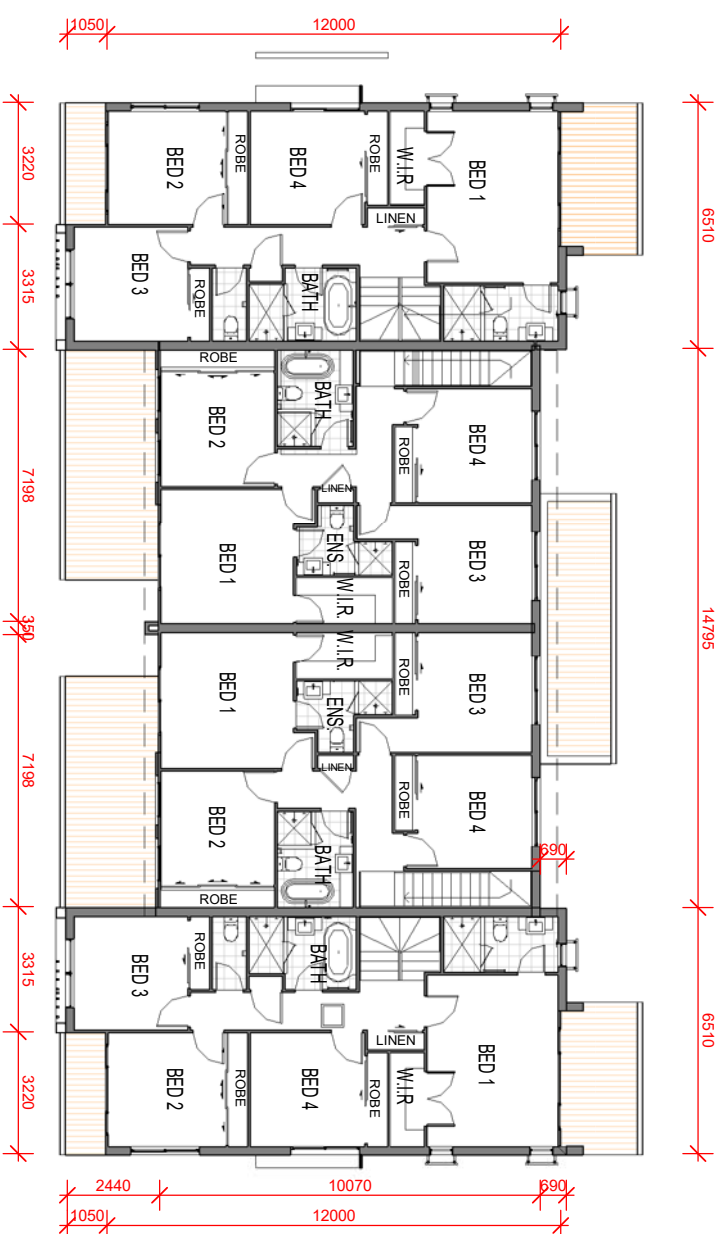

2 FIRST FLOOR PLAN (1-200)
DA-2.05 SCALE - 1 : 200

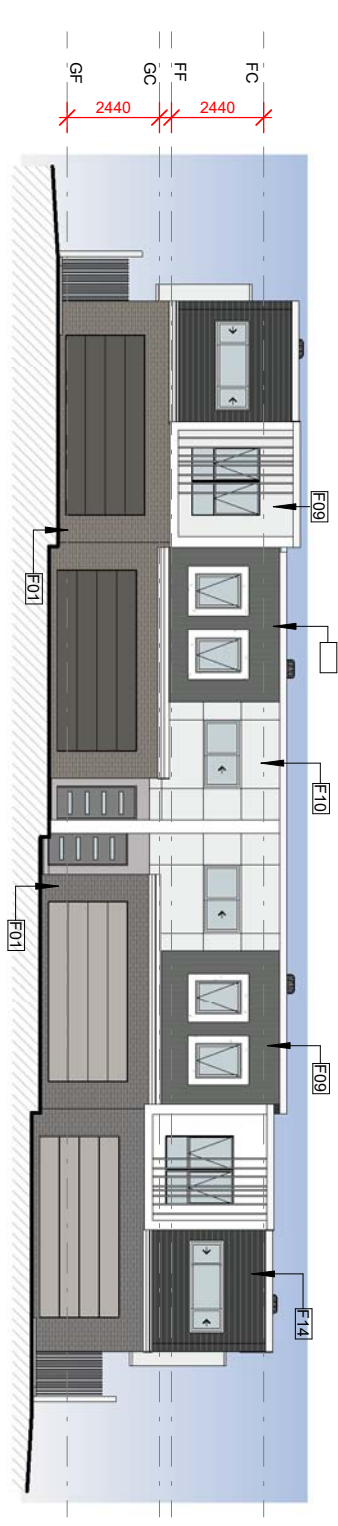

3 1/200 FRONT ELEVATION
DA-2.05 SCALE - 1 : 200

GFA 471.6 m²
Site Cover 382.3 m²



4 1/200 LEFT ELEVATION
DA-2.05 SCALE - 1 : 200

| EXTERNAL FINISHES | |
|-------------------|---|
| F01 | FACE BRICKWORK (AS SELECTED) |
| F02 | BRICKWORK WITH TEXTURE FINISH |
| F03 | BRICKWORK WITH RENDER FINISH (COLOUR 1) |
| F04 | BRICKWORK WITH RENDER FINISH (COLOUR 2) |
| F09 | SCYON AXON CLADDING |
| F10 | SCYON MATRIX CLADDING |
| F14 | HARDIES LINEA BOARDING |
| F22 | COLORBOND TRIMDEK METAL ROOF SHEETING (AS SELECTED) |
| F37 | NRG BOARD |

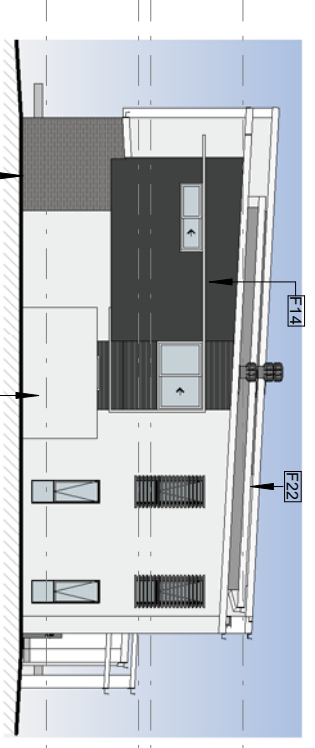

5 1/200 RIGHT ELEVATION
DA-2.05 SCALE - 1 : 200

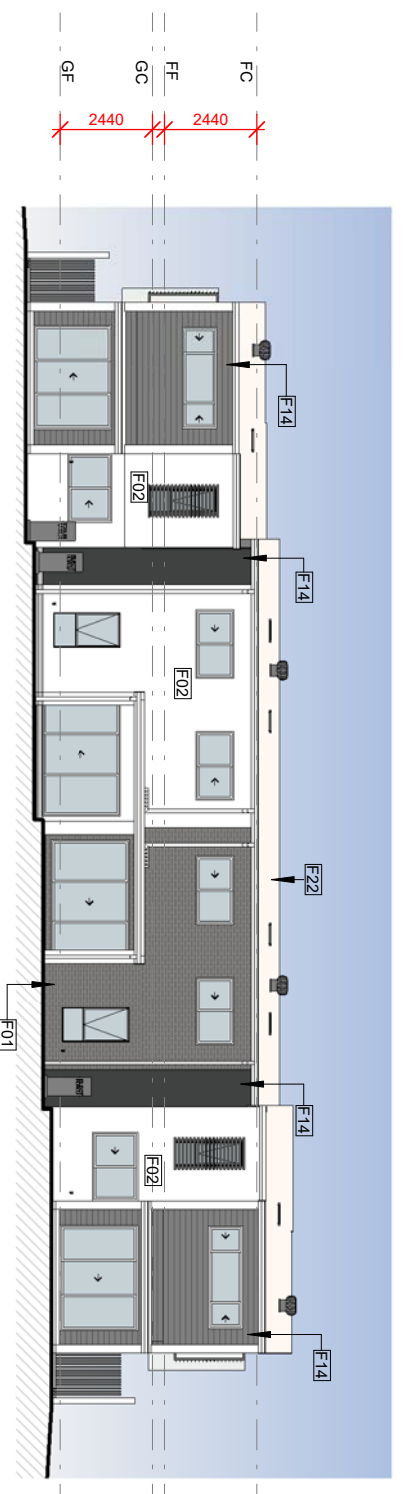

6 1/200 REAR ELEVATION
DA-2.05 SCALE - 1 : 200

HIGHWAY DEVELOPMENTS
No1 PTY LTD

| No. | Description | Date |
|-----|--------------|----------|
| 1 | MINOR CHANGE | 24.07.20 |
| 2 | AMEND PATIOS | 04.08.20 |

| Project | | Unit Type | | Sheet Name | |
|--|--|--|--|-------------------|--|
| MULTIPLE DWELLING UNITS | | TYPE A & B QUAD | | DA SHEET | |
| Location 200 NOTTINGHAM RD, PARKINSON | | Unit Number BUILDING 7 & 9 - UNIT 17-20 & 24-27 | | Scale 1 : 200 | |
| Client HIGHWAY DEVELOPMENTS No1 PTY LTD | | Project Number 0000 | | Drawn by TB | |
| | | | | Date JULY 2020 | |
| | | | | Revision 2 | |

Site: Town House Development, Curranholmgum Rd 200, PARKINSON VIC 3013. DRAWING: WESTPORT EASTPORT QUAD 04

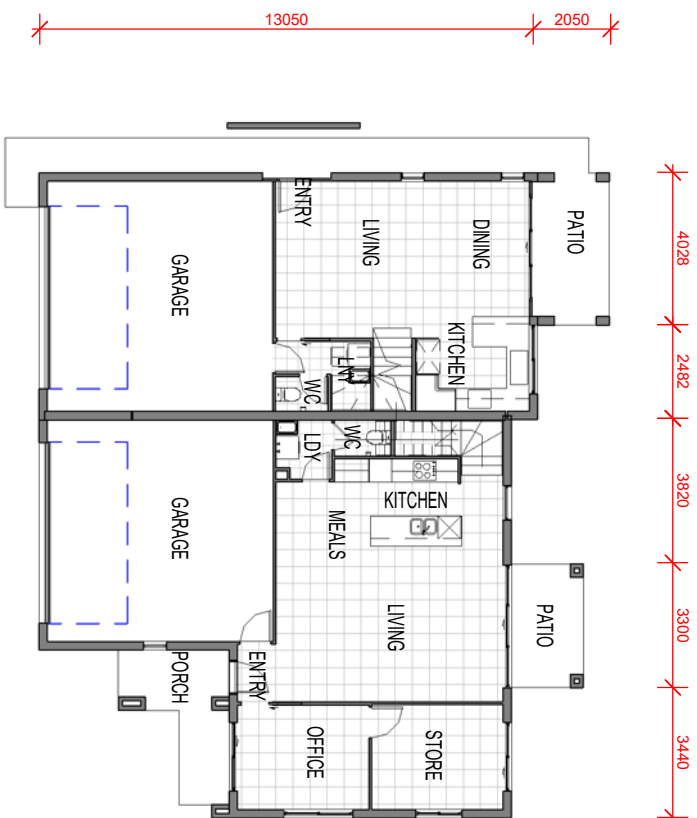

1 GROUND FLOOR PLAN (1-200)
DA-2.06 SCALE - 1 : 200

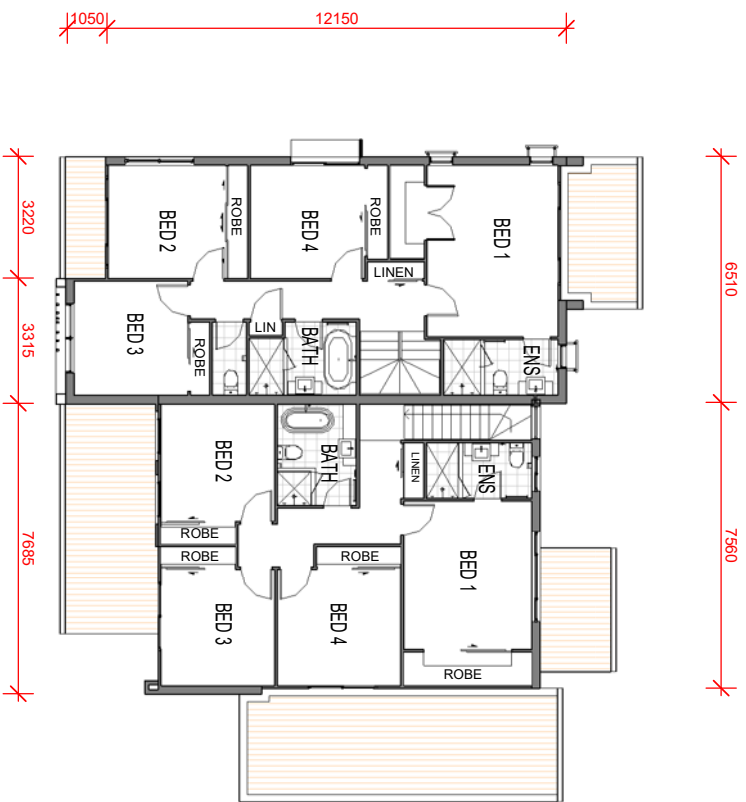

2 FIRST FLOOR PLAN (1-200)
DA-2.06 SCALE - 1 : 200

GFA 262.1 m²
Site Cover 212.9 m²

| EXTERNAL FINISHES | |
|-------------------|---|
| F01 | FACE BRICKWORK (AS SELECTED) |
| F02 | BRICKWORK WITH TEXTURE FINISH |
| F03 | BRICKWORK WITH RENDER FINISH (COLOUR 1) |
| F04 | BRICKWORK WITH RENDER FINISH (COLOUR 2) |
| F14 | HARDIES LINEA BOARDING |
| F36 | VERTICAL ALUMINIUM SCREEN |



3 1/200 FRONT ELEVATION
DA-2.06 SCALE - 1 : 200

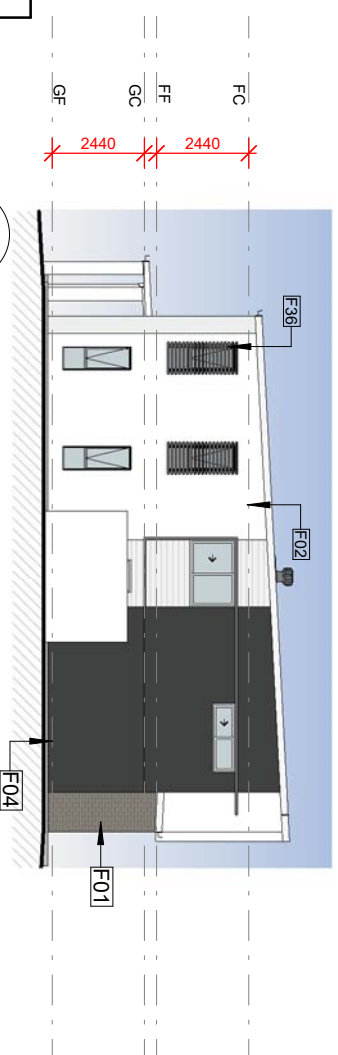

4 1/200 LEFT ELEVATION
DA-2.06 SCALE - 1 : 200

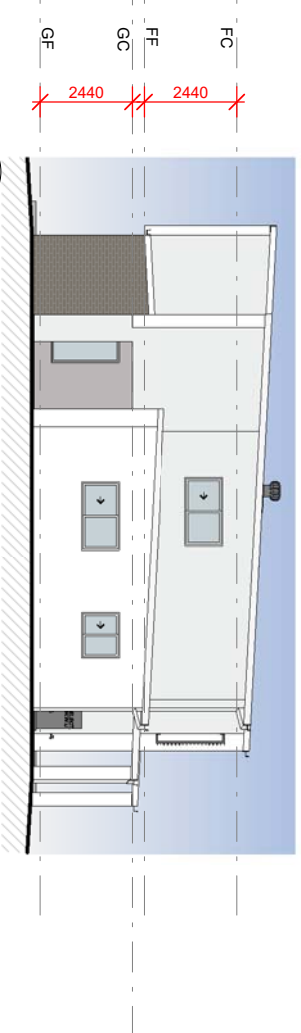

5 1/200 RIGHT ELEVATION
DA-2.06 SCALE - 1 : 200



6 1/200 REAR ELEVATION
DA-2.06 SCALE - 1 : 200

HIGHWAY DEVELOPMENTS No.1 PTY LTD

| No. | Description | Date |
|-----|--------------|----------|
| 1 | MINOR CHANGE | 24.07.20 |
| 2 | AMEND PATIOS | 04.08.20 |

| Project | | Unit Type | | Sheet Name | |
|---|--|---|--|---------------------------|--|
| MULTIPLE DWELLING UNITS | | TYPE A & B DUPLEX - MANAGER | | DA SHEET | |
| Location 200 NOTTINGHAM RD, PARKINSON | | Unit Number BUILDING 10 - UNIT 28-29 | | Scale 1 : 200 | |
| Client HIGHWAY DEVELOPMENTS No.1 PTY LTD | | Project Number 0000 | | Drawing Number DA-2.06 | |
| | | Date JUNE 2020 | | Revision 2 | |

Schedule 12 – Origin Embedded Network Agreement



CENTRALISED ENERGY EQUIPMENT – MASTER AGREEMENT TERMS

This Master Agreement is between Origin Energy Electricity Limited (ABN 33 071 052 287) (referred to as "us", "we" or "our") and the Premises Party specified in the Schedule (referred to as "you" or "your").

SCHEDULE

Item 1: ORIGIN'S DETAILS

Origin Energy Electricity Limited
ABN: 33 071 052 287
Address for notices: GPO Box 186 Melbourne Vic 3001
Telephone number: 1800 684 993
Representative: Mike Hamlin

Item 2: PREMISES PARTY'S DETAILS

Premises Party: Highway Developments No.1 Pty Ltd
ABN: 42 625 791 844
Address for notices: 301/50 Marine Parade Southport Qld 4215
Telephone number: 07) 5528 0111
Representative: Peter Honeyman

Item 3: PREMISES & PLAN

Address of Premises: 200 Nottingham Rd Parkinson Qld 4115
Description of Premises: 29 Residential townhouses
Plan: Lot 146 on RP88878

EXECUTED as an agreement

SIGNED for and on behalf of Origin Energy Electricity Limited ABN 33 071 052 287 by its duly authorised representative:

MLJH

SIGNED for and on behalf of Highway Developments No.1 Pty Ltd ABN: 42 625 791 844 by its duly authorised representative:



Adrian Wardle (Oct 28, 2020 10:41 GMT+10)

Signature of authorised representative

Adrian Wardle

Name of authorised representative

National Sales Manager

Title of authorised representative

Date **28/10/2020**



Heran Building Group (Oct 27, 2020 16:41 GMT+10)

Signature of authorised representative

Heran Building Group

Name of authorised representative

Development Manager

Title of authorised representative

Date **27/10/2020**

Assignment and Assumption Agreement for Master Agreement between Origin Energy Electricity Limited and Highway Developments No.1 Pty Ltd ABN: 42 625 791 844 as the original Premises Party for 200 Nottingham Rd Parkinson Qld 4115.

A. The parties executing this Assignment and Assumption Agreement agree:

(i) With effect from the Date of Assignment:

- (a) the original Premises Party assigns to the Owners Corporation all rights and benefits under the Master Agreement and all Supply Orders to which, but for this Assignment and Assumption Agreement, the original Premises Party would have been entitled to on or after the Date of Assignment; and
- (b) the Owners Corporation accepts the assignment of the original Premises Party's rights and benefits under the Master Agreement and all Supply Orders pursuant to clause A(i)(a) of this Assignment and Assumption Agreement.

(ii) With effect on and from the Date of Assignment, the Owners Corporation:

- (a) assumes and must perform all obligations and discharge all liabilities under the Master Agreement and all Supply Orders that, but for this Assignment and Assumption Agreement, the original Premises Party would have been required to perform or discharge on and after the Date of Assignment; and
- (b) is bound by and must comply with all other provisions of the Master Agreement and all Supply Orders which, but for this Assignment and Assumption Agreement, the original Premises Party would have been bound by on and after the Date of Assignment.

(iii) We consent to:

- (a) the assignment of the rights and benefits under the Master Agreement and all Supply Orders to the Owners Corporation pursuant to clause A(i) of this Assignment and Assumption Agreement and acknowledge that the Owners Corporation is entitled to the rights and benefits under the Master Agreement and all Supply Orders to which, but for this Assignment and Assumption Agreement, the original Premises Party would have been entitled to on and after the Date of Assignment; and
- (b) the Owners Corporation, pursuant to clause A(ii) of this Assignment and Assumption Agreement, assuming and performing the original Premises Party's obligations and discharging the original Premises Party's liabilities under the Master Agreement and all Supply Orders that arise or are to be performed or discharged by the original Premises Party on or after the Date of Assignment.

(iv) With effect on and from the Date of Assignment, we release the original Premises Party from all obligations and liabilities under the Master Agreement and all Supply Orders to be performed or discharged on or after the Date of Assignment.

(v) Nothing in this Assignment and Assumption Agreement:

- (a) affects the original Premises Party's or our rights, liabilities or obligations under the Master Agreement and all Supply Orders before the Date of Assignment; or
- (b) releases the original Premises Party or us from any obligation or liability under the Master Agreement and all Supply Orders arising before the Date of Assignment and the Owners Corporation does not assume any such obligation or liability.

(vi) On and from the Date of Assignment, the address and contact details of the Premises Party for the purpose of notices issued under the Master Agreement and all Supply Orders will be as notified by the Owners Corporation under the Agreement from time to time.

B. Prior to executing this Assignment and Assumption Agreement, the Owners Corporation must provide us with a valid Australian Business Number.

C. By signing this Assignment and Assumption Agreement, the Owners Corporation represents and warrants that:

- (i) it validly exists under the law of the place of its incorporation, has the power to sign this Assignment and Assumption Agreement, the Master Agreement and all Supply Orders and has all authority and rights needed to perform them;
- (ii) all information it provides, or causes to be provided, to the other parties is accurate, up to date and complete; and
- (iii) signing or performing this Assignment and Assumption Agreement, the Master Agreement and all Supply Orders will not breach, conflict with or infringe any other obligation, agreement, Regulatory Requirement or Encumbrance by which it is bound.

The Common Seal of _____
[insert full name of Owners Corporation]

ABN _____ [Insert] was
affixed in the presence of:

Signature of Secretary

Name of Secretary

Signature of Chairman

Name of Chairman

Date

SIGNED for and on behalf of Highway Developments No.1
Pty Ltd ABN: 42 625 791 844 by its duly authorised
representative in the presence of:

Signature of witness

Name of witness

Signature of authorised representative

Name of authorised representative

Title of authorised representative

Date

SIGNED for and on behalf of Origin Energy Electricity
Limited ABN 33 071 052 287 by its duly authorised
representative in the presence of:

Signature of witness

Name of witness

Signature of authorised representative

Name of authorised representative

Title of authorised representative

Date

1. THIS AGREEMENT

- 1.1 This Master Agreement is made up of these Master Agreement Terms and the Schedule.
- 1.2 To the extent of any inconsistency, the various parts of this Agreement prevail over the terms of each other part in the following order:
 - (a) these Master Agreement Terms;
 - (b) the Schedule;
 - (c) any special conditions to a Supply Order; and
 - (d) the remaining terms of the relevant Supply Order.
- 1.3 Capitalised terms used in this Agreement are defined in clause 36.
- 1.4 You acknowledge that you enter into this Agreement for the benefit of each Origin Company.
- 1.5 We hold the benefit of this Agreement (including the right to recover any Liability) for our self and on trust for each Origin Company and are entitled to enforce this Agreement (including any indemnity), whether by way of equitable, legal or statutory relief, for our self and on behalf of any Origin Company.

2. TERM

- 2.1 This Master Agreement starts on the Start Date and, subject to clause 35.3, continues until it is terminated by you or us.
- 2.2 The term of each Supply Order is as set out in the Supply Order.

3. SUPPLY ORDERS

- 3.1 Any services we provide pursuant to this Master Agreement must be provided under a Supply Order.
- 3.2 During the Term, you may request us to provide services at the Premises by making a written request to us specifying:
 - (a) the general nature of the services sought; and
 - (b) any other information we may request relating to the services sought.
- 3.3 We must respond to a request under this clause in writing and advise:
 - (a) that we do not agree to your request; or
 - (b) that we agree to provide the services, in which case, we will prepare a draft Supply Order and provide it to you.
- 3.4 If signed by both parties during the Term, each executed Supply Order forms a separate agreement between you and us.
- 3.5 The terms and conditions that will apply to each Supply Order are the terms set out in this Master Agreement and the relevant Supply Order. The terms of one Supply Order do not apply to the terms of any other Supply Order.
- 3.6 Each Supply Order must state our reference number for this Master Agreement.
- 3.7 We may nominate any Origin Company to be the provider of services and the party to a Supply Order.

4. OUR APPOINTMENT

- 4.1 You agree that we will:
 - (a) be the sole operator of the Centralised Energy Equipment; and
 - (b) offer Retail Services,

at the Premises.

5. YOUR INFRASTRUCTURE

- 5.1 You must, at no cost to us and as soon as practicable:
 - (a) in the case of a New Development, install, commission, operate, maintain and repair or arrange for the installation, commissioning operation, maintenance and repair of the Premises Party Infrastructure at the Premises;
 - (b) in the case of Retrofit Developments:
 - (i) replace or arrange for the replacement of, any Premises Party Infrastructure so that it is compatible with the Centralised Energy Equipment and operate, commission, maintain and repair or arrange for the operation, commissioning, maintenance and repair of the Premises Party Infrastructure at the Premises; and
 - (ii) give our Representatives access to remove the existing infrastructure which is being replaced with the Centralised Energy Equipment; and
 - (c) undertake all other infrastructure, plumbing, piping, electrical or other work at the Premises, required for us to install, commission, operate and maintain the Centralised Energy Equipment and provide the Retail Services.
- 5.2 The Premises, Premises Party Infrastructure and work undertaken under clause 5.1 must:
 - (a) be free from Defects;
 - (b) be fit for its usual purpose;
 - (c) be compatible with the Centralised Energy Equipment; and
 - (d) be installed, operated, maintained and repaired:
 - (i) in accordance with all Approvals and applicable Regulatory Requirements (including those relating to units within the Premises at which life support equipment is in use) and the Final Drawings for the Premises; and
 - (ii) in a safe, timely, competent, efficient and professional manner which meets or exceeds the requirements of Good Industry Practice.
- 5.3 You must promptly advise us of any Defects in relation to the Premises or Premises Party Infrastructure.
- 5.4 You must notify us:
 - (a) at least 10 Business Days before any planned outage or interruption; and
 - (b) as soon as possible of any unplanned outage or interruption,

of the Premises Party Infrastructure which may affect our operation of the Centralised Energy Equipment or the supply of Retail Services to any Customer.
- 5.5 You must provide us with copies of the Proposed Drawings for the Premises before the time specified in a Supply Order. You must consult with us in relation to these drawings. If:

- (a) we notify you that we cannot install or operate the Centralised Energy Equipment or provide the Retail Services at the Premises due to the design shown in the Proposed Drawings; and
- (b) you do not change the design so that we can carry out the installation, operation and provide the Retail Services.

we may terminate the relevant Supply Order by notice to you, effective immediately.

- 5.6 After following clause 5.5, you must provide us with Final Drawings for the Premises acceptable to us including for the purposes of compliance with Regulatory Requirements.
- 5.7 If specified in a Supply Order, once the Centralised Energy Equipment is installed, you must connect that equipment to the Premises Party Infrastructure in accordance with all applicable Regulatory Requirements.
- 5.8 You must comply with all Regulatory Requirements at all times in relation to health, safety and the environment for the Premises and the Premises Party Infrastructure.
- 5.9 You must ensure that no aspect of the Premises (or its occupation by you or Customers) interferes with the operation and use of the Centralised Energy Equipment, including wireless transmission functionality for the remote reading of meters. You will undertake and pay for any alterations or works required at the Premises to remove any deficiency in wireless signal strength.

6. CENTRALISED ENERGY EQUIPMENT

- 6.1 We must supply, install and commission the Centralised Energy Equipment at the Premises at no cost to you (unless a cost is specified in a Supply Order):
 - (a) for New Developments, at the stage of construction requested by you, provided your request is in accordance with usual industry practice;
 - (b) for Retrofit Developments, once we have removed the equipment which is being replaced with the Centralised Energy Equipment;
 - (c) once we are satisfied that it is safe to do so;
 - (d) once any conditions precedent set out in a Supply Order have been satisfied or waived by us; and
 - (e) once all Approvals relating to the Premises, Premises Party Infrastructure or Centralised Energy Equipment have been obtained, if those Approvals are required to be obtained prior to the installation of the Centralised Energy Equipment.
- 6.2 The Centralised Energy Equipment must:
 - (a) be free from Defects;
 - (b) be fit for its purpose as specified in a Supply Order or if not specified, its usual purpose;
 - (c) be compatible with the Premises Party Infrastructure; and
 - (d) be installed, commissioned, operated, maintained and repaired:
 - (i) in accordance with all Approvals and applicable Regulatory Requirements

(including those relating to units within the premises at which life support equipment is in use); and

- (ii) in a safe, timely, competent, efficient and professional manner which meets or exceeds the requirements of Good Industry Practice.
- 6.3 You must promptly notify us, by contacting our National Response Centre by telephone on 1800 002 438, of any faults you identify with the Centralised Energy Equipment.
- 6.4 If we identify any faults with the Centralised Energy Equipment, we will, at our discretion, either replace or repair the faulty part of the Centralised Energy Equipment.
- 6.5 We may temporarily deactivate or remove (or both) all or part of the Centralised Energy Equipment at any time:
 - (a) if we believe it is appropriate in an emergency, for safety reasons, to protect the Centralised Energy Equipment or to prevent loss or damage being suffered by us or you; or
 - (b) for repairs, maintenance or testing, or to replace all or part of the Centralised Energy Equipment.

If we do so we must reactivate or reinstall the Centralised Energy Equipment as soon as reasonably practicable and must use best endeavours to avoid or minimise disruption to the Retail Services.

- 6.6 We must comply with all Regulatory Requirements at all times in relation to health, safety and the environment for the Centralised Energy Equipment.
- 6.7 We retain title to the Centralised Energy Equipment unless and until we transfer that title in accordance with this Agreement. You have no right to possession or custody of the Centralised Energy Equipment.
- 6.8 We retain title to the Remote Electronic System and title to that system will not pass to you in any circumstances, unless otherwise expressly agreed in the Supply Order.
- 6.9 You must provide or make available all assistance, information, utilities and amenities (such as electricity and water) reasonably necessary in order for us to perform our obligations under this Agreement, including for us to install, repair, maintain, operate, commission, remove and replace the Centralised Energy Equipment.
- 6.10 The parties agree that the Centralised Energy Equipment is a chattel and not a fixture.

7. ACCESS TO AND LICENCE OVER THE PREMISES

- 7.1 You grant us and our Representatives a non-exclusive licence to access the Premises, including the Common Property, as reasonably required for the purposes of this Agreement, including to allow us or our Representatives to:
 - (a) install, operate, inspect, maintain, repair, replace, disconnect, reconnect or remove the Centralised Energy Equipment;
 - (b) store equipment and materials on the Premises in connection with removal or installation, or the performance of any other obligation of ours under a Supply Order;

- (c) read, disconnect or reconnect any Meter; and
 (d) supply the Retail Services.
- 7.2 You grant us and our Representatives a non-exclusive licence over, and for the use and enjoyment of, those parts of the Premises where the Centralised Energy Equipment is to be installed or located and areas reasonably needed to access it.
- 7.3 You acknowledge and agree the access and use under the licences granted in clauses 7.1 and 7.2 will not interfere, to an unreasonable extent, with the use or enjoyment of any part of the Premises, including the Common Property.
- 7.4 You must ensure our Representatives' access to the Premises is safe, convenient and unhindered. You must ensure our Representatives can access the Premises:
- (a) immediately if we need access urgently, for example, to prevent loss or damage being suffered by you, a Customer or us; or
 (b) otherwise between 9am – 6pm on a Business Day, within 3 Business Days of the date we contact you to arrange to do so; or
 (c) as otherwise specified in a Supply Order.
- 7.5 The licences in clauses 7.1 and 7.2 will automatically be created on and from the Start Date. They will continue until our Representatives have removed the Centralised Energy Equipment from the Premises or until title to the Centralised Energy Equipment transfers to you in accordance with this Agreement
- 7.6 While accessing the Premises, our Representatives will comply with any reasonable procedures, including site safety procedures, relating to the Premises previously specified to us by you. Where you require us to comply with any such procedure, you must provide:
- (a) us with a written copy of it; and
 (b) training to all our Representatives accessing the Premises in how to comply with it.
- 7.7 You must notify us in writing of any special hazards or danger attaching to the Premises.
- 8. APPROVALS**
- 8.1 You must obtain any Approval relating to the Premises and the Premises Party Infrastructure, and, if specified in a Supply Order, Your Centralised Energy Equipment Approvals, within any time period set by the Regulatory Requirements or, if no such time period is set, then promptly and without delay.
- 8.2 We must obtain any Approval (other than Your Centralised Energy Equipment Approvals) relating to the Centralised Energy Equipment within any time period set by the Regulatory Requirements or, if no such time period is set, then promptly and without delay.
- 8.3 You must co-operate to facilitate the procurement of any Approval relating to the Centralised Energy Equipment within any time period set by the Regulatory Requirements.
- 8.4 A party may terminate a Supply Order immediately by notice to the other party, and clause 16 will apply, if any Approval is:
- (a) not obtained within any time period set by the Regulatory Requirements;
 (b) is obtained subject to conditions which impose obligations on that party or its equipment which are unacceptable to that party, acting reasonably;
 (c) where no time period is set by the Regulatory Requirements, not obtained promptly and without delay;
 (d) refused; or
 (e) revoked, terminated or otherwise ceases to apply.
- 8.5 We may terminate a Supply Order immediately by notice to you, and clause 16 will apply, if any condition precedent specified in that Supply Order is not met or waived by us within 24 months of the execution of the Supply Order by both parties. We may extend the 24 month period by notice to you.
- 9. MUTUAL OBLIGATIONS**
- 9.1 In performing its obligations under this Agreement, each party must:
- (a) comply with all Regulatory Requirements;
 (b) not, by its act or omission, place the other party in breach of any Regulatory Requirement or Approval; and
 (c) provide all things and take all measures necessary to protect people and property.
- 9.2 Any warranty or guarantee required by law to be incorporated into this Agreement is incorporated. Any warranty, guarantee or implied term which can be excluded by law is excluded.
- 10. YOUR OBLIGATIONS FOR CENTRALISED ENERGY EQUIPMENT**
- 10.1 You must:
- (a) prevent any damage to the Centralised Energy Equipment, including by securing the Centralised Energy Equipment in a locked area or as otherwise specified in a Supply Order;
 (b) notify us immediately if you become aware that any such equipment is missing, stolen or damaged; and
 (c) ensure that neither you nor any of your Representatives or any third party damages, tampers, interferes or otherwise deals with any part of the Centralised Energy Equipment, except where reasonably necessary for the purpose of public safety or preventing material damage to property
- 10.2 You are responsible for, and must reimburse us for, any damage to or interference with any of the Centralised Energy Equipment located or installed at the Premises other than:
- (a) normal wear and tear; or
 (b) damage as a result of any act or omission by our Representatives.
- 10.3 If you require us to relocate the Centralised Energy Equipment to another location at the Premises, then you must obtain all necessary Approvals and pay all of our costs in doing so prior to us doing the work.

11. RETAIL SERVICES

- 11.1 We will offer to supply Retail Services to the occupants at the Premises:
- once the relevant infrastructure is in place and we are satisfied it is safe to do so;
 - subject to our standard credit, identification and other checks in relation to any Customer;
 - on terms which include or are consistent with any customer term set out in a Supply Order; and
 - except to the extent varied by paragraph (c), on our standard terms.
- 11.2 We will enter into agreements for Retail Services with individual Customers who elect to take up our offer and:
- impose charges and fees on each Customer in respect of the supply of the Retail Services to that Customer (subject to clause 11.1);
 - invoice each Customer for the supply of Retail Services to them on cycles determined by us;
 - collect payment of accounts from each Customer; and
 - connect and disconnect the Retail Services with each Customer,
- in each case in accordance with the terms of the relevant Customer agreement.
- 11.3 You must not disconnect any Customer's Retail Services or the Centralised Energy Equipment.
- 11.4 We may exchange information with our Related Bodies Corporate, Representatives and service providers where required to perform our obligations under this clause 11.
- 11.5 You must:
- refer all matters relating to the Retail Services or individual Customer agreements to us; and
 - not enter into any agreement, arrangement or undertaking with, or make any representation or give any undertaking or commitment to, a Customer concerning the Retail Services or their customer agreement.

12. INVOICING

- 12.1 If a Supply Order provides that you must pay an amount to us, we will issue invoices to you after the end of each calendar month in which an amount becomes payable by you.

13. PAYMENT AND DISPUTES

- 13.1 Unless you dispute an invoice or part of an invoice, you must pay the amount of a valid invoice to us by the Due Date.
- 13.2 If you fail to pay an invoice in full or in accordance with clause 13.5 by the Due Date, we may:
- charge you Interest on the unpaid amount from the Due Date; and
 - recover our costs of enforcing payment of the invoice from you.
- 13.3 Where you dispute an invoice you must provide us with written notice setting out why the amount of the invoice is incorrect by the Due Date.
- 13.4 We will assess your claim as soon as reasonably practicable and advise if we agree the original invoice was incorrect. If we do not agree with your

claim the dispute resolution procedures in clause 21 apply.

- 13.5 Where you dispute part of any invoice and the dispute is not resolved by the Due Date, you must pay by the Due Date the undisputed amount.
- 13.6 Once the dispute is resolved, if a party owes another party an amount it must pay that amount within 8 weeks from the date the dispute is resolved.

14. CUSTOMER DETAILS AND PRIVACY

- 14.1 Each party must comply with the *Privacy Act 1988* (Cth).
- 14.2 If we are unable to contact an owner or occupier of a unit (who is a current or potential Customer), you must use reasonable endeavours to assist us to deliver written communications from us to the owner or occupier at the unit.
- 14.3 We may collect, hold, use and disclose Personal Information about you, Customers or Personnel disclosed to us in the course of performing this Agreement or providing any Retail Services in accordance with our Privacy Policy and the applicable privacy collection statements (see originenergy.com.au/privacy).

15. TERMINATION

- 15.1 A party may terminate a Supply Order (in part or in full):
- if the other party is subject to an Insolvency Event;
 - if the other party is in breach of the relevant Supply Order and fails to remedy that breach within 1 month of receipt of a notice to do so;
 - immediately upon notice to the other party if an event of Force Majeure which has been notified in accordance with clause 25 continues for more than 3 months in respect of that Supply Order;
 - if any representation or warranty made by the other party is untrue or misleading (whether by omission or otherwise) when made.
- 15.2 Without limiting clause 15.1, we may terminate a Supply Order in the following circumstances:
- in accordance with clause 5.5; or
 - in accordance with clause 8.5.
- 15.3 Either party may terminate:
- a Supply Order in accordance with clause 8.4; or
 - this Master Agreement or any Supply Orders at any time by giving the other party not less than 6 months written notice, unless, in the case of a Supply Order, specified otherwise in that Supply Order.
- 15.4 If this Master Agreement is terminated in accordance with this clause 15, any and all Supply Orders entered into under this Master Agreement in place immediately prior to such termination will remain in effect until the earlier of:
- the end of the relevant Supply Term; and
 - the relevant Supply Order is terminated in accordance with this clause 15.
- 15.5 Termination of this Agreement is without prejudice to the rights of the parties occurring before the date of termination.

16. WHAT HAPPENS IF A SUPPLY ORDER IS TERMINATED

16.1 Subject to any applicable Regulatory Requirements, if a Supply Order is terminated for any reason we will cease supplying the applicable Retail Services under this Agreement from the date of termination.

16.2 In addition to any rights arising as a consequence of termination for breach, if a Supply Order is terminated for any reason other than termination by us under clause 15.3(b) and after the Centralised Energy Equipment has been installed at the Premises, then we may at our option:

- (a) sell the Centralised Energy Equipment to you and you must purchase the Centralised Energy Equipment from us. The date of the sale will be the date we notify you that we have elected to sell the Centralised Energy Equipment to you. The price payable by you for the Centralised Energy Equipment will be the value of the Centralised Energy Equipment as determined in accordance with the relevant Supply Order. Title to the Centralised Energy Equipment will pass to you once the invoice is paid in full;
- (b) remove the Centralised Energy Equipment on reasonable notice; or
- (c) forfeit the Centralised Energy Equipment to you, in exchange for the payment of the sum of \$1.00 on request. The date of the forfeiture will be the date we notify you that we have elected to forfeit the Centralised Energy Equipment to you. Title to the Centralised Energy Equipment will pass to you on the date of forfeiture,

but if we terminate a Supply Order under clause 15.3(b), then only clause 16.1(b) or (c) will apply at our option, unless you and we agree in writing an alternative arrangement in relation to the Centralised Energy Equipment.

16.3 In addition to any rights arising as a consequence of termination for breach, if a Supply Order is terminated for any reason other than termination by us under clause 15.3(b) and before the Centralised Energy Equipment has been installed at the Premises, then we may require you to pay:

- (a) our administration costs as determined under the Supply Order;
- (b) any other costs, charges and expenses incurred by us in connection with our performance, or preparation for performance, of the Agreement, provided that if a particular cost, charge or expense is attributable to Centralised Energy Equipment that we believe can be productively redeployed by us within 3 months from the date of termination then we will discount the amount you are required to pay in respect of that cost, charge or expense by the percentage specified in the Supply Order; and
- (c) Interest on working capital allocated to, or expensed in relation to, the Supply Order, not exceeding the total amount specified in the Supply Order.

16.4 You must pay any amount payable under this clause 16 within 1 month of receipt of an invoice from us.

16.5 If title to the Centralised Energy Equipment is transferred to you in accordance with clauses 16.1(a) or (c), the Centralised Energy Equipment will transfer to you in the condition it is in at the date of the sale or forfeiture (as relevant) and all risk in the Centralised Energy Equipment will pass to you on that date. We will not be required to conduct any maintenance or repairs prior to (or after) transferring the Centralised Energy Equipment to you.

16.6 If we remove the Centralised Energy Equipment in accordance with clause 16.1(b), we will leave the Premises in a safe and functional condition (taking into account fair wear and tear). However, we will not remedy any aesthetic damage such as scratching or fading of walls or roof, or repair damage not caused by us or the Centralised Energy Equipment.

16.7 In this clause 16, the Centralised Energy Equipment does not include the Remote Electronic System unless otherwise expressly provided in the Supply Order.

17. ENTRY INTO THIS AGREEMENT BY OWNERS CORPORATION

17.1 This clause 17 only applies for New Developments. References to Supply Orders in this clause 17 refer to Supply Orders executed prior to the Date of Assignment.

17.2 You must register the Plan in respect of the Premises promptly or, if the Premises is in New South Wales, as soon as reasonably practicable.

17.3 If the Premises is in Queensland, South Australia, Victoria, Western Australia, the Australian Capital Territory or the Northern Territory, promptly after registration of the Plan you must procure the Assignment and Assumption Agreement be signed by both the Owners Corporation and by you, to give effect to the assignment and assumption documented in this clause 17.

17.4 If the Premises is in NSW, promptly after registration of the Plan and before settlement of any sales of units in the Premises, you must hold an inaugural general meeting of the Owners Corporation and procure the Assignment and Assumption Agreement be signed by both the Owners Corporation and by you, to give effect to the assignment and assumption documented in this clause 17.

17.5 You must provide us with a copy of the executed Assignment and Assumption Agreement immediately after it is executed and dated by you and the Owners Corporation.

17.6 The effective transfer of this Master Agreement and all Supply Orders will occur when the Assignment and Assumption Agreement is signed by all of the Owners Corporation, the original Premises Party and us.

18. WARRANTIES

18.1 Each party represents and warrants that:

- (a) it validly exists under the law of the place of its incorporation, has the power to sign this Agreement and has all authority and rights needed to perform it;
- (b) all information it provides, or causes to be provided, to the other party is accurate, up to date and complete; and

- (c) signing or performing of this Agreement will not breach, conflict with or infringe any other obligation, agreement, Regulatory Requirement or Encumbrance by which it is bound.

18.2 The representations and warranties set out in this clause 18 are made, given and repeated on the Start Date, the Date of Assignment and each following day until all Supply Terms in respect of Supply Orders have ended.

19. PARTNERSHIPS AND TRUSTS

19.1 If you are a partner in a partnership, each partner is jointly and severally liable under this Agreement.

19.2 If you enter this Agreement as a trustee you represent and warrant in your own right and as trustee of the Trust, that as at the date of this Agreement and until such time as all your obligations under this Agreement are discharged:

- (a) you are the sole trustee of the Trust;
- (b) you have the requisite capacity and authority to enter this Agreement on behalf of, and to bind the beneficiaries of, that Trust and to perform all obligations under this Agreement pursuant to the documents governing that Trust; and
- (c) you have the right to be fully indemnified out of the assets of the Trust in relation to this Agreement and the assets of the Trust are sufficient to satisfy all obligations of the Trust under this Agreement.

20. INDEMNITIES AND LIABILITY

20.1 You indemnify us and our Representatives against any claim or from any Liability we incur or suffer in connection with or arising from this Agreement, relating to:

- (a) your breach of this Agreement, a Regulatory Requirement or an Approval or contributing to our breach of a Regulatory Requirement or an Approval;
- (b) your negligence or that of your Representatives; and
- (c) any personal injury, illness, disease or death of:
 - (i) any of your Representatives; and
 - (ii) any of our Representatives or any third party, but in this case only to the extent that such personal injury, illness, disease or death is caused or contributed to by an act or omission (whether negligent or otherwise) or by a breach of duty (whether statutory or otherwise) of you or your Representatives.

20.2 Neither party nor its Representatives are liable, and must not make a claim against, the other party for any Excluded Loss in connection with or arising from this Agreement.

20.3 Subject to clause 20.4, to the extent permitted by law, the total aggregate Liability of a party to the other party in connection with or arising from this Agreement is limited to the greater of:

- (a) \$100,000; and
- (b) the Installation Value of the Centralised Energy Equipment.

20.4 The limitation of Liability in clause 20.3 will not apply:

- (a) for any Liability for personal injury, illness, disease or death; or
- (b) to the extent that a party is either entitled to be indemnified or paid for that Liability under any insurance policy held by that party or would have been so entitled or paid if it had:
 - (i) complied with its insurance obligations under this Agreement;
 - (ii) promptly claimed, and diligently pursued, such claim under that insurance policy; and
 - (iii) complied with the terms and conditions of that insurance policy; or
- (c) for any Liability under the indemnity in clause 28.2.

21. DISPUTE RESOLUTION

21.1 All disputes must be dealt with in accordance with this clause 21.

21.2 The party claiming the dispute must give a written notice to the other party setting out particulars of the dispute (Dispute Notice).

21.3 The dispute must be referred to authorised representatives of the parties. The authorised representatives must meet (by telephone if not in person) within 2 weeks and negotiate to resolve the dispute.

21.4 If for any reason the dispute has not been resolved within 4 weeks after service of the Dispute Notice either party may commence court proceedings.

21.5 Pending the resolution or determination of a dispute, each party must continue to perform their respective obligations under this Agreement.

21.6 Nothing in this clause 21 prevents a party from:

- (a) seeking urgent interlocutory or declaratory relief where, in that party's reasonable opinion, that action is necessary to protect that party's rights; or
- (b) terminating this Agreement where it has a right under the Agreement to do so.

22. CONFIDENTIALITY

22.1 Each party must keep all Confidential Information confidential.

22.2 A party may disclose Confidential Information:

- (a) with the other party's prior written consent;
- (b) on a confidential basis, to a potential purchaser of its shares or assets or the shares or assets of any of its Related Bodies Corporate;
- (c) on a confidential basis to its Representatives, advisers, financiers or potential financiers and insurers or potential insurers (or those of a Related Body Corporate) to the extent disclosure is reasonably required; or
- (d) if required by Regulatory Requirements or applicable stock exchange rules.

23. ASSIGNMENT

23.1 We may assign, transfer or novate this Agreement (including the licences granted to us under clause

7) to any of our Related Bodies Corporate or any third party by prior notice to you.

23.2 Except as provided for in clause 17 or 23.3, you may only assign, transfer or novate this Agreement with our prior written consent.

23.3 If you sell or otherwise dispose of your interest in the Premises, in part or in full, prior to the Owners Corporation entering this Agreement in accordance with clause 17, you must:

- (a) notify us of the intended disposal;
- (b) give written notice to any sales agents and prospective purchasers about this Agreement;
- (c) if you dispose of your full interest in the Premises, novate this Agreement to the Purchaser (on terms acceptable to us acting reasonably) so that the Purchaser will be bound by your obligations under this Agreement as if the Purchaser had originally entered into this Agreement as you; and
- (d) if you dispose of part of your interest in the Premises, procure that the Purchaser is also bound by your obligations under this Agreement in relation to its part interest in the Premises (on terms acceptable to us acting reasonably).

23.4 If you are the Owners Corporation, you must not Encumber this Agreement.

24. SUBCONTRACTING

24.1 We may subcontract all or part of our obligations under this Agreement to any third party. We may perform any obligations under this Agreement through a Representative.

24.2 For Premises in Victoria:

- (a) we will enter into a contract with a subcontractor to carry out the installation, commissioning, operation, maintenance, repairs, deactivation and removal of the Centralised Energy Equipment;
- (b) despite anything else in this Agreement, any reference in this Agreement to us performing any service described in clause 24.2(a) is a reference to us arranging for our subcontractor to perform those services; and
- (c) nothing in this Agreement obliges or requires us to carry out, or to arrange or manage the carrying out of, any domestic building work within the meaning of the Domestic Building Contracts Act 1995 (Vic).

25. FORCE MAJEURE

25.1 A party will be excused for any non performance of its obligations under this Agreement (other than an obligation to pay money) during the time and to the extent that Force Majeure prevents the party from doing so.

25.2 A party must:

- (a) try to remove, overcome or minimise the effects of Force Majeure as soon as it can; and
- (b) give the other party prompt notice of the Force Majeure including details of its expected duration.

25.3 If the effects of such an event are widespread, we may give you prompt notice by making the

necessary information available on a 24 hour telephone service promptly after becoming aware of the event.

26. INSURANCE

26.1 For New Developments, you must, or must cause your contractors and subcontractors to, obtain and maintain until practical completion of construction of the Premises, with a major insurance company carrying on general insurance business in Australia, "Construction All Risks" insurance for a liability of not less than the full value of construction including the full value of the Centralised Energy Equipment as notified by us to you.

26.2 You must obtain and maintain for the Supply Term, with a major insurance company carrying on general insurance business in Australia:

- (a) any insurance required by a Regulatory Requirement; and
- (b) current third party public and product liability insurance covering liability to us, our Representatives and any third party for death or bodily injury (including illness) and loss of and/or damage to (or loss of use of) any property arising out of anything done or omitted to be done by you and liabilities arising from sudden and accidental pollution for the following minimum amounts:
 - (i) for public liability - \$10 million per incident; and
 - (ii) for products liability - \$10 million for any 12 month period.

26.3 You must obtain and maintain from the date of practical completion of the building and for the remainder of the Supply Term, with a major insurance company carrying on general insurance business in Australia, building insurance for a liability of not less than the full value of the building including the full value of the Centralised Energy Equipment as notified by us to you.

26.4 On request from us you must provide us with evidence of the insurances maintained in accordance with this clause 26.

27. GST

27.1 In this clause, all terms that are defined in the GST law have the same meaning in this clause.

27.2 Unless otherwise stated, monetary amounts are stated exclusive of any GST component. Amounts calculated by reference to monetary amounts are to be calculated on the GST exclusive component.

27.3 If a taxable supply is made under or in connection with this Agreement, then subject to the recipient receiving a tax invoice, the recipient agrees to pay to the supplier an additional amount (GST Amount) equal to the applicable rate of GST multiplied by the amount of the consideration for the taxable supply. The GST Amount is payable at the same time as the consideration is payable for the supply. Where a party reimburses or indemnifies another party for an expense or other amount, the reimbursement or indemnification will be net of any input tax credit the other party (or its representative member) is entitled to claim.

28. TAXES

- 28.1 Prior to signing this Agreement, you must provide us with a valid Australian Business Number. We will have no obligations under this Agreement until you provide a valid Australian Business Number to us.
- 28.2 If we are required in our opinion to withhold any amount in respect of tax from a payment to be made to you under this Agreement, we are entitled to do so and such withholding and payment to the relevant taxing authority will be a good discharge of our obligation to pay the relevant amount to you. In the event that we pay an amount to you without withholding an amount in respect of tax, you indemnify us for any loss suffered by us as a result of failing to withhold.

29. LAWS APPLICABLE TO THIS AGREEMENT

- 29.1 This Agreement is governed by the laws in force in the state or territory where the Premises is located.
- 29.2 Each party submits to the non-exclusive jurisdiction of the courts of that place.

30. PERSONAL PROPERTY SECURITIES ACT

- 30.1 We may apply for any registration, or give any notice, in connection with this Agreement under the PPSA. You consent to such registration or notice and agree to waive your right to receive a verification statement, and agree not to make an amendment demand.
- 30.2 Except where required by section 275(7) of the PPSA, information of the kind mentioned in section 275(1) of the PPSA must not be disclosed by either party.

31. VARIATIONS TO THIS AGREEMENT AND WAIVER

- 31.1 Unless otherwise specified in this Agreement, any variations to the terms of this Agreement or any waiver of any rights of any party has no effect unless it is in writing and signed by the parties (in the case of a variation) or the party granting the waiver (in the case of a waiver).
- 31.2 A party's failure or omission to exercise, enforce or require strict or timely compliance with any provision of this Agreement does not affect or impair that provision, or the right of that party to avail itself of the remedies it may have in respect of any breach of that provision.

32. NOTICES

- 32.1 A notice or other communication under this Agreement is only effective if:
- (a) in writing and addressed to the person to whom it is given; and
- (b) sent by:
- (i) email to the email address notified by the relevant party to the other party; or
- (ii) mail to the relevant party's address for notices as specified in the Schedule or amended by a party by notice to the other party.
- 32.2 A notice is given:
- (a) if sent by email – 24 hours after the email was sent, unless the sender receives an automated message that the email was not delivered or knows the email was not delivered or could not be read; or

- (b) if sent by mail – if sent by priority mail, 3 Business Days after posting, or if sent by regular mail, 6 Business Days after posting.

33. ANTI-BRIBERY

- 33.1 Each party must ensure that in connection with this Agreement it and its Representatives have complied and will comply with all applicable anti-bribery, fraud, secret commission and corruption laws.
- 33.2 Each party confirms that it and its Representatives have not received, and will not receive, any payment, benefit or other thing of value (whether by way of gift, kickback or otherwise) in connection with this Agreement that is not legitimately due to it or its Representatives.
- 33.3 A party must not make any facilitation payment in connection with this Agreement.
- 33.4 Each party agrees that it and its Representatives:
- (a) have not offered, given, promised, or authorised giving; and
- (b) will not offer, give, promise, or authorise giving, directly or indirectly, money or anything of value to a government official for any purpose in connection with this Agreement.

34. CHANGE OF LAW

- 34.1 If there is a Change of Law we may change the terms of this Agreement to the extent reasonably required as a result of the Change of Law, including to avoid a breach of any Regulatory Requirement.
- 34.2 We will give you notice of any changes to the terms, and the date they will apply from, as a result of Change of Law as soon as practicable. The changes may be retrospective back to the date of the Change of Law. We will provide, on your request, reasonable information and explanation about the changes.

35. GENERAL PROVISIONS

- 35.1 This Agreement supersedes all prior and other negotiations, representations, proposals, understandings and agreements, whether written or oral, relating to the subject matter of this Agreement.
- 35.2 You acknowledge you have not relied on any predictions, forecasts, advice or statements of opinion by us, or any of our employees or agents, as to the appropriateness or financial effect of this Agreement or the provision of any Retail Services or market conditions.
- 35.3 Clauses 7, 16, 17.6, 18, 19.2, 20, 21, 22, 26, 27 and 28 survive termination or expiry of this Agreement. Other terms of this Agreement will survive termination or expiry of this Agreement where it is necessary for it to do so to enable a party to enforce a right accrued on or before termination or expiry.
- 35.4 It is not necessary for us to incur an expense or make a payment before enforcing a right of indemnity conferred by this Agreement.
- 35.5 If any part of this Agreement is unlawful, unenforceable or invalid, that part will be treated as removed from the Agreement, but the rest of the Agreement is not affected.

36. DEFINITIONS

The following definitions apply in this Agreement unless the context requires otherwise.

Approval means any licence, permit, consent, authorisation, approval, registration, determination, certificate, exemption, filing, notice, qualification or other requirement (and any conditions attached to any of them) of or issued by any Regulatory Authority that must be obtained, held or satisfied by a party to supply, perform, receive or use the services to be supplied or perform that party's obligations under this Agreement or otherwise in relation to this Agreement.

Assignment and Assumption Agreement means the agreement of that name which is incorporated into this Master Agreement (or a copy in the same terms as that agreement).

Australian Standards means the standards developed and approved by or on behalf of Standards Australia Limited ABN 85 087 326 690 and designated as an "Australian Standard".

Business Day means a day which is not a Saturday, Sunday or a state wide public holiday in the state in which the Premises is located.

Centralised Energy Equipment means:

- (a) the apparatus, equipment and accessories installed or to be installed by our Representatives at the Premises as set out in a Supply Order; and
- (b) any Remote Electronic System identified in a Supply Order, except to the extent expressly excluded by this Agreement.

Change of Law means:

- (a) a change in any Regulatory Requirement or Tax;
 - (b) any variation in the interpretation, effect or administration of any Regulatory Requirement or Tax,
- taking effect after the Agreement Date, that has or will directly or indirectly affect:
- (c) the costs or benefits that we or one of our Related Bodies Corporate have or will incur in connection with this Agreement, or
 - (d) the performance or enjoyment of this Agreement by either party,

except that a Change of Law does not apply if the event in question relates to income tax as defined in the Income Tax Assessment Act 1997 (Cth).

Common Property means all the areas of the Premises which are owned or controlled by you including the areas shown as common property on the Plan.

Confidential Information means:

- (a) this Master Agreement;
- (b) any Supply Order;
- (c) all information relating to the value of the Centralised Energy Equipment or Remote Electronic System disclosed or made available to a party by or on behalf of the other party; or
- (d) all information a party derives or produces, whether in whole or in part, from the information disclosed under paragraphs (a) to (c).

Customer means any person who enters into a contract with us for the purchase of, or who uses (without having agreed to a written contract with us), Retail Services at the Premises. Where you are supplied with Retail Services, Customer includes you.

Date of Assignment means the date on which the Assignment and Assumption Agreement is signed by the last party to do so.

Defect means, with respect to the Centralised Energy Equipment, Premises or any Premises Party Infrastructure:

- (a) any error, defect, omission, deficiency, non-conformity, fault, failure, malfunction or discrepancy of any type and howsoever arising, whether or not in comparison against any Regulatory Requirement, Australian Standard, Approval or any warranty or guarantee (including a performance warranty or guarantee) (as the context requires); or
- (b) any other failure to comply with the requirements of this Agreement.

Dispute Notice has the meaning given in clause 21.2.

Due Date means the date for payment set out on the invoice.

Encumbrance includes any mortgage, charge, pledge, lien, encumbrance, assignment, security interest, title retention, possessory right, preferential right, trust arrangement, contractual right of set-off or any other security agreement or arrangement in favour of any person by way of security for the payment of a debt or any other obligation.

Excluded Loss means any:

- (a) loss of contract, profit, revenue or anticipated savings;
- (b) loss of or damage to, reputation, credit rating or goodwill;
- (c) loss or denial of opportunity;
- (d) loss of access to markets;
- (e) overheads and wasted expenditure;
- (f) financing costs;
- (g) special, incidental or punitive damages; or
- (h) any loss or damage arising from special circumstances that are outside the ordinary course of things,

however arising in respect of any circumstances under or in connection with this Agreement, and regardless of whether a claim for same is made under this Agreement, a Regulatory Requirement, tort, negligence, strict liability, under an indemnity or a warranty, in equity or otherwise.

Final Drawings means the final version of the Proposed Drawings.

Force Majeure means, with respect to an obligation of a party under this Agreement, any event or circumstance that:

- (a) occurs on or after the Start Date and is not within the reasonable control of that party;
- (b) could not be prevented, overcome or remedied by the exercise of due diligence and Good Industry Practice by that party; and
- (c) results in that party being unable to meet or perform that obligation or delays its ability to do so,

and includes any event or circumstance in connection with a pandemic declared by the World Health Organisation or an Australian government, despite the pandemic itself having commenced prior to the commencement of this Agreement as long as it meets the criteria in paragraphs (a) to (c) other than in respect of the timing of the event or circumstance.

Good Industry Practice means, in relation to any activity, the standard of skill, care, diligence and workmanship that would be exercised by a skilled person who is experienced in carrying out activities of the same or similar nature.

GST has the meaning given in the GST law.

GST law has the same meaning as in the *A New Tax System (Goods and Services Tax) Act 1999* (Cth).

Insolvency Event means a party becomes insolvent, bankrupt or otherwise cease trading or a liquidator, receiver, administrator or similar official is appointed to the party or all of the assets of the party or the party is otherwise unable to pay its debts as and when they fall due.

Installation Value means the value specified in a Supply Order, being the estimated value of the Centralised Energy Equipment including installation cost.

Interest means the rate of interest on any day which is the average bid rate for bills having a tenor of 90 days which is displayed on the page of the Reuters Monitor System designated "BBSY" plus 2%, calculated daily, and at our discretion, compounded monthly.

Liability includes any loss, damage, liability, cost, charges and expenses.

Master Agreement Terms means this document.

Meter means a meter installed at the Premises pursuant to a Supply Order to measure Retail Services used by a Customer.

New Development means a development where you are undertaking or have undertaken the construction of the Premises.

Origin Company means us and any of our Related Bodies Corporate.

Owners Corporation means the body corporate or owners corporation for the Premises whose identity and contact details (including full name, ABN, address for notices, telephone number and contact representative) have been notified to us.

Personal Information has the meaning given in the *Privacy Act 1988* (Cth).

Personnel means those persons who a party uses to perform that party's obligations, whether an employee, director, officer, representative, contractor, subcontractor, agent of or seconded to, that party or any of its Related Bodies Corporate or otherwise.

Plan means:

- (a) if the Premises are in South Australia, the plan of community division and scheme description;
- (b) if the Premises are in Queensland, the plan and community management statement;
- (c) if the Premises are in the Northern Territory, the scheme statement;
- (d) if the Premises are in the Australian Capital Territory, the registered units plan;
- (e) if the Premises are in Victoria or Western Australia, the registered plan of subdivision;
- (f) if the Premises are in New South Wales, the registered strata plan of subdivision,

set out in item 3 of the Schedule.

Premises:

- (a) means the building (or, before construction, the proposed building) and land at the address described in item 3 of the Schedule; and

- (b) includes the Common Property; and

- (c) if the Premises is in Queensland or South Australia, then once the Plan is registered, also includes the scheme land (excluding the lots in the scheme).

Premises Party means the party specified in item 2 of the Schedule or an Owners Corporation to who this Agreement is assigned and novated to as contemplated by clause 17.

Premises Party Infrastructure means the piping, plumbing, electrical and other infrastructure set out in a Supply Order, but excluding the Centralised Energy Equipment.

Proposed Drawings means the proposed drawings specified in a Supply Order.

Purchaser means a transferee or assignee of your interest in the Premises.

Regulatory Authority means:

- (a) any government or a governmental, quasi governmental or judicial entity or authority;
- (b) a stock exchange; and
- (c) any other authority, agency, commission, regulator, ministry, department, instrument, tribunal (including any pricing body), enterprise or similar entity,

that has powers or jurisdiction under any Regulatory Requirement over a party or any act relating to this Agreement.

Regulatory Requirement means:

- (a) any act, regulation or other statutory instrument or proclamation of any applicable jurisdiction in which any act or obligation in connection with this Agreement is or is to be carried out or regulated;
- (b) any applicable law, whether of a legislative, equitable or common law nature;
- (c) any applicable Australian Standards and codes (including voluntary codes with which we or any of our Related Bodies Corporate have committed to comply); and
- (d) any judgment, decree or similar order with mandatory effect or any binding requirement or mandatory approval of a Regulatory Authority, including any Approval,

relevant to the supply, performance, receipt or use of the services to be supplied, or to the performance of a party's obligations, under this Agreement or otherwise relevant to a party.

Related Body Corporate has the meaning given in the *Corporations Act 2001* (Cth).

Remote Electronic System means the software and hardware used by us to read the Meters remotely.

Representative means a party's Personnel and any other officer, director, employee, representative, agent of or seconded to, a party or any of its Related Bodies Corporate.

Retail Services means the provision of retail services by us to Customers as described in a Supply Order.

Retrofit Development means a Premises that has been constructed and existing infrastructure to provide the Retail Services is in place.

Schedule means the schedule to this Master Agreement.

Start Date means the date by which this Master Agreement is signed by both the original Premises Party and us.

Supply Order means a supply order established and signed pursuant to this Agreement in respect of particular Centralised Energy Equipment.

Supply Term means, in respect of a Supply Order, the term of the Supply Order as specified in it.

Tax means a tax (including corporate tax, resource rent tax, income tax, fringe benefits tax, payroll tax, PAYG and subcontractor's taxes), levy, duty (including customs duty and stamp duty), excise, charge, royalty (whether based on value, profit or otherwise), fee, surcharge, contribution, impost, deduction or withholding, however it is described, whether direct or indirect, by whatever method collected or recovered, that is imposed by a Regulatory Requirement or by a Regulatory Authority, in any jurisdiction (including a liability on an entity as a result of its being jointly or severally liable for another entity's Tax).

Term means the period from the Start Date until the effective termination of this Master Agreement.

Trust means the trust identified in item 2 of the Schedule (if applicable).

Your Centralised Energy Equipment Approvals means the Approvals or the connections, consents, confirmations, reports, opinions, agreements or other requirements, by, from or with, third parties that must be obtained for the installation and operation of the Centralised Energy Equipment, and which you must obtain in accordance with a Supply Order.

37. INTERPRETATION

Unless otherwise stated:

- (a) a reference to this Agreement or another document includes any variation or replacement of any of it;

- (b) the singular includes the plural and vice versa;
- (c) a reference to a statute, code or other law includes regulations and other instruments or directives under it and consolidations, amendments, re-enactments or replacements of any of them;
- (d) a person includes any type of entity or body, whether or not it is incorporated or has a separate legal identity, and any executor, administrator, successor or permitted assigns;
- (e) a reference to a body (other than a party) which ceases to exist, or whose powers or function are transferred to another body, is a reference to the body which replaces it or substantially succeeds to its powers or functions;
- (f) specifying anything after the words "include" "including", "for example" or similar expression does not limit what is included;
- (g) the expression "relating to" and similar grammatical expressions includes arising from, concerning or in connection with (whether directly or indirectly);
- (h) a reference to a Liability incurred or suffered by us includes Liabilities of our Related Bodies Corporate relating to the relevant matter;
- (i) a reference to a variation of a Charge includes introducing a new charge;
- (j) a reference to "this Agreement" in these Master Agreement Terms is to be read as a reference to the Master Agreement or a Supply Order as the context requires.

SUPPLY ORDER – METERING EQUIPMENT FOR EMBEDDED NETWORKS

Origin details ("we, us, our"): Origin Energy Electricity Limited ABN 33 071 052 287

Premises Party details ("you, your"): Highway Developments No.1 Pty Ltd ABN: 42 625 791 844, 301/50 Marine Pde Southport Qld 4215
Supply Order Date: The date this Supply Order is executed by the last party.

Originating Master Agreement Reference Number: MF200NOTT210820

1. SUPPLY ORDER TERMS

- 1.1 This Supply Order sets out the terms upon which we will provide the Centralised Energy Equipment to you, procure construction services from you and offer Retail Services to Customers.
- 1.2 The terms of this Supply Order comprise:
 - (a) the terms set out in this Supply Order; and
 - (b) the terms set out in the Master Agreement Terms, which are incorporated into this Supply Order by reference (as if set out in full).

2. SUPPLY TERM

- 2.1 The period from the date this Supply Order is executed by the last of the parties to do so until the effective termination of this Supply Order.
- 2.2 This Supply Order must not be terminated by either party pursuant to clause 15.3(b) of the Master Agreement.
- 2.3 Either party may terminate:
 - (a) this Supply Order by giving the other party written notice no earlier than six months and no later than three months prior to the end of the Initial Term (**Termination Notice**). If neither party gives the other party a Termination Notice, then this Supply Order will be renewed for a further period of five years commencing on the day after the expiry of the Initial Term (**Renewed Term**); or
 - (b) this Supply Order after the expiry of the Renewed Term, by giving the other party not less than six months' notice in writing.
- 2.4 As between us and the Owners Corporation, for the purposes of regulation 119 of the Body Corporate and Community Management (Standard Module) Regulation 2008 (Qld), this Supply Order will be deemed to have commenced between us and the Owners Corporation on the Date of Assignment, notwithstanding that the Supply Order will have commenced earlier than that as between us and the original Premises Party.

2.5

3. SPECIAL CONDITIONS (REFER CLAUSE 1.2(C) MASTER AGREEMENT TERMS)

- 3.1 From no later than the date the Premises is permanently connected to the national electricity market, and then for the remainder of the Supply Term, you must ensure that we are the account holder for the sale of electricity to, and Financially Responsible for, the Gate Meter.
- 3.2 If this Supply Order is terminated, you must appoint another person to be Financially Responsible for the Gate Meter from the effective date of termination.
- 3.3 You must ensure that the embedded electrical network at the Premises is not used to supply electricity to any person other than the original Premises Party before the Supply Order is transferred to the Owners Corporation in accordance with clause 17 of the Master Agreement Terms.
- 3.4 We must, before any electricity is supplied to a person other than the relevant Premises Party, cooperate with the Owners Corporation to ensure that the Owners Corporation obtains any necessary registrations or exemptions required in accordance with the relevant Regulatory Requirements to permit the Owners Corporation to own, operate and/or control any embedded electrical network at the Premises.
- 3.5 Clause 15.3 of the Master Agreement Terms is deleted and replaced with the following:

"15.3 Either party may terminate:

 - (a) a Supply Order in accordance with clause 8.4; or
 - (b) this Master Agreement or any Supply Orders (in part or in full) at any time by giving the other party not less than 6 months written notice, except that you must not terminate this Master Agreement or any Supply Orders during the Initial Term."
- 3.6 In this Supply Order:

Gate Meter means the meter that records the total amount of electricity supplied from the national electricity market to the Premises.

Financially Responsible has the meaning given to that term in the National Electricity Rules.

SUPPLY ORDER – METERING EQUIPMENT FOR EMBEDDED NETWORKS

Initial Term means the period from the Start Date to the fifth anniversary of the date the Master Agreement and this Supply Order are transferred to the Owners Corporation under clause 17 of the Master Agreement Terms.

Installation Value means the value identified in clause 8.2.

4. CENTRALISED ENERGY EQUIPMENT

4.1 Centralised Energy Equipment to be provided (Refer clause 6 Master Agreement Terms)

The quantities and items below are based on the information provided by you before the date this Supply Order is executed by the last party. If that information changes, then we may vary the quantities and items by notice to you.

| Item description | Quantity |
|---|----------|
| Three Phase Whole Current Electricity Meter | 30 |
| Remote Electronic System | 1 |

4.2 Purpose of Centralised Energy Equipment (Refer clause 6.3(b) Master Agreement Terms)

The purpose of the Centralised Energy Equipment is its usual purpose within the meaning of the National Measurement Institute Pattern Approval Requirements NMI M 6-1 and NMI M 6-2.

4.3 Access and security requirements for Centralised Energy Equipment (Refer clauses 7.3(c) and 10.1(a) Master Agreement Terms)

Nil

4.4 Connection of Centralised Energy Equipment to the Premises Party Infrastructure (Refer clause 5.7 Master Agreement Terms)

You must connect the Centralised Energy Equipment to the Premises Party Infrastructure.

5. DRAWINGS (REFER CLAUSE 5.5 MASTER AGREEMENT TERMS)

5.1 Drawings to be provided are the electrical schematic drawings for the Premises.

5.2 Proposed Drawings must be provided before the main switchboard has been manufactured.

6. PREMISES PARTY INFRASTRUCTURE (REFER CLAUSE 5 MASTER AGREEMENT TERMS)

6.1 The Premises Party Infrastructure includes:

- (a) the embedded electrical network, that is, the system of electric lines, switchboards and other hardware, used by you to take delivery of electricity from a distribution system and distribute electricity within the Premises;
- (b) the Gate Meter; and
- (c) the equipment set out in clauses 6.2 and 6.3 below.

6.2 For whole current metering installations you must provide the following equipment:

- (a) Metering panels and associated wiring. Meter panels must be constructed of insulating material and:
 - (i) comply with Australian Standard 3439 or the equivalent international standard developed by the International Electrotechnical Commission; and
 - (ii) be suitable for their intended use and environment, including exposure to ultra violet where exposed to daylight.
- (b) Supply fuse, to be installed upstream of each metering installation.

6.3 For current transformer metering installations you must provide the following equipment:

- (a) Metering panels and current transformer chambers. Meter panels must be constructed of insulating material and:
 - (i) comply with Australian Standard 3439 or the equivalent international standard developed by the International Electrotechnical Commission; and
 - (ii) be suitable for their intended use and environment, including exposure to ultra violet where exposed to daylight.
- (b) Continuous conduit draw wire.
- (c) Current transformer chambers with 32 amp fuses.

SUPPLY ORDER – METERING EQUIPMENT FOR EMBEDDED NETWORKS

7. RETAIL SERVICES AND RETAIL SERVICES TERMS (REFER CLAUSE 11 MASTER AGREEMENT TERMS)

7.1 In this Supply Order, Retail Services means the sale of electricity by us, and associated meter reading, billing and collection services.

7.2 We will offer Retail Services to the Customers incorporating electricity usage rates that are:

- (a) set on a date chosen by us which will be a date after the Start Date but before we begin to enter into agreements for the Retail Services with individual Customers who elect to take up our offer (Set Date); and
- (b) re-set by us in each successive year in January, if the Customer is in Victoria, or in July in other areas, or at any other time in our absolute discretion (Re-set Date).

8. VALUATION UPON TERMINATION AFTER INSTALLATION (REFER CLAUSE 16.2 OF THE MASTER AGREEMENT TERMS)

8.1 The valuation of the Centralised Energy Equipment will be calculated as follows:

The value of the Centralised Energy Equipment will be the Disbursed Cost plus Administration Cost, which in total will not exceed the Installation Value.

For this purpose:

Disbursed Cost means the cost of the Centralised Energy Equipment (excluding the Remote Electronic System) which is:

- a) 100% of the Installation Value; and
- b) progressively reduced by 10% after each anniversary of the Date of Installation, such that after the 10th anniversary it will be zero.

Date of Installation means the date we start providing Retail Services to Customers at the Premises, as determined by us.

Administration Cost means an amount that is:

- (a) 10% of the Installation Value at the Supply Order Date; and
- (b) reduced by 10% after each anniversary of the Supply Order Date, such that after the 10th anniversary it will be zero.

8.2 The Installation Value of the Centralised Energy Equipment is:

- (a) \$17,823.30 inclusive of GST at the current rate of 10%.
- (b) If the current rate of GST changes, the GST inclusive amount will be recalculated based on the GST exclusive amount which is \$16,203.00.

9. TERMINATION BEFORE INSTALLATION (REFER CLAUSE 16.3 OF THE MASTER AGREEMENT TERMS)

9.1 For clause 16.3(a) of the Master Agreement Terms:

- (a) the value of the administration costs will be calculated in accordance with the following table:

| Item | Period within which termination notice is given | Administration costs as a percentage of the Estimated Value |
|------|---|---|
| 1 | Less than 3 months from the Supply Order Date | 3.5% |
| 2 | At least 3 months, but less than 6 months, from the Supply Order Date | 7% |
| 3 | At least 6 months from the Supply Order Date | 10% |

- (b) there will be no cost, charge or expense for Centralised Energy Equipment.

9.2 The total amount will not exceed \$1,782.33 inclusive of GST.

SUPPLY ORDER – METERING EQUIPMENT FOR EMBEDDED NETWORKS

EXECUTED as an agreement

SIGNED for and on behalf of Origin Energy Electricity Limited ABN 33 071 052 287 by its duly authorised representative:

MLJH

SIGNED for and on behalf of Highway Developments No.1 Pty Ltd ABN: 42 625 791 844 by its duly authorised representative:

Adrian Wardle

Adrian Wardle (Oct 28, 2020 10:41 GMT+10)

Signature of authorised representative

Adrian Wardle

Name of authorised representative

National Sales Manager

Title of authorised representative

Date 28/10/2020



Heran Building Group (Oct 27, 2020 16:41 GMT+10)

Signature of authorised representative

Heran Building Group

Name of authorised representative

Development Manager

Title of authorised representative

Date 27/10/2020



18th September 2020

Attention: Mr Peter Honeyman
Highway Developments No.1 Pty Ltd
301/50 Marine Parade
SOUTHPORT QLD 4215

Dear Peter,

Premises: 200 Nottingham Rd Parkinson Qld 4115
Equipment: Electric Instantaneous Water Heaters (further described in clause 1)

Origin Energy Retail Limited ABN 22 078 868 425 (**Origin**) and Highway Developments No.1 Pty Ltd ABN: 42 625 791 844 (**Premises Party**) have entered into a Master Agreement Reference Number: MF200NOTT210820 (**Agreement**) in relation to the Premises.

As part of this relationship, Origin is providing the Premises Party with the Equipment at the Premises on the terms and conditions of this letter. Any terms defined in this letter have the same meaning as in the Agreement, unless otherwise specified.

1. Origin will supply the Equipment on the Assumptions as described below, and upon request the Premises Party will pay Origin \$1.00.

| | |
|---------------------|---|
| Equipment | 29 x Stiebel Eltron Model HDB-E 27 AU (or similar) |
| Installation | Origin will not install Equipment. |
| Suitability | The Equipment has been unconditionally approved by the Premises Party as suitable and fit for purpose in every respect. |
| Value | \$18,850.00 exclusive of GST |

2. You grant us, our agents and contractors a non-exclusive licence to access the Premises to deliver the Equipment.
3. The parties acknowledge and agree that title to, and risk in, the Equipment passes to the Premises Party when the Equipment has been delivered.
4. The Premises Party acknowledges and agrees that from the date on which the Equipment is delivered at the Premises (**Delivery Date**):
 - a. the Equipment will become part of the Premises Party Infrastructure;
 - b. the Premises Party will engage directly with the manufacturer of the Equipment in relation to any maintenance, servicing, testing or repair services and any other service requirements of the Equipment, and will pay any fees or charges in connection with those services; and
 - c. Origin will have no responsibility whatsoever for any maintenance, servicing, testing, repair or any other services in connection with the Equipment at any time.
5. To the fullest extent permitted by law, the parties agree that Origin will not be liable to the Premises Party, the Owners Corporation or any third party for any loss, damage, liability, cost, charges or expenses in connection with the Equipment or this letter, except as expressly set out in this letter agreement.
6. Neither party is liable to, and must not make a claim against, the other party for any Excluded Loss (as defined in the Agreement) in connection with or arising from this letter.

Page 1 of 3

7. Each party must do all things reasonably necessary to mitigate any loss or damage incurred under this letter agreement.
8. To the extent permitted by law, the only warranties or guarantees that apply to this letter agreement are those that are expressly set out in this letter agreement and any statutory guarantees that may apply under consumer protection laws and which cannot be excluded. To the extent permitted by law, our liability in respect of any statutory guarantees that apply to this letter is limited, to the extent that it is fair and reasonable and at our discretion, to:
 - (a) replacing the Equipment with equivalent equipment;
 - (b) arranging for an appropriately qualified person to undertake repairs of the Equipment;
 - (c) paying the cost of replacing the Equipment with equivalent equipment; or
 - (d) paying the cost of having the Equipment repaired.
9. Following practical completion of the construction of the Premises, the Premises Party must procure that the Owners Corporation agrees in writing to the terms of this letter agreement at or prior to the Owners Corporation entering into the Agreement. This letter will apply to the Owners Corporation (in the same way it applies to the Premises Party) as if the Owners Corporation had signed this letter.

Yours sincerely,

Adrian Wardle

Adrian Wardle (Sep 18, 2020 17:08 GMT+10)

Adrian Wardle
National Sales Manager
Centralised Energy Services



Origin
Level 24, 180 Ann Street, Brisbane QLD 4000
t 07 38670525 m 0476835362
e adrian.wardle@originenergy.com.au

The Premises Party may accept the terms of this letter by signing a copy and returning it to Origin. When signed by the Premises Party, the contents of this letter will form an agreement between Origin and the Premises Party.

SIGNED for and on behalf of **Highway Developments No.1 Pty Ltd ABN 42 625 791 844** by its duly authorised representative in the presence of:

Heran Building Group (Oct 27, 2020 16:41 GMT+10)

Signature of authorised representative

Heran Building Group

Name of authorised representative

Development Manager

Title of authorised representative

Date / /

27/10/2020



EMBEDDED NETWORK MANAGER SERVICES AGREEMENT

This Agreement is between Origin Energy Retail Limited (ABN 22 078 868 425) (referred to as "us", "we" or "our") and the Premises Party specified in Schedule 1 (referred to as "you" or "your").

BACKGROUND

- A. We are an accredited and registered Embedded Network Manager under the National Electricity Rules.
- B. You are an owner and/or operator of an embedded network at the Premises (**Embedded Network**), and are required under the National Electricity Rules to either act as, or appoint, an Embedded Network Manager for the Embedded Network.
- C. You wish to appoint us as the Embedded Network Manager for the Embedded Network.
- D. We agree to accept this appointment, to perform the role of Embedded Network manager and to provide the ENM Services in accordance with the terms of this Agreement.

1. THIS AGREEMENT

- 1.1 This Agreement is made up of these Agreement Terms and the Schedules.
- 1.2 To the extent of any inconsistency, the various parts of this Agreement prevail over the terms of each other part in the following order:
 - (a) these Agreement Terms;
 - (b) the Schedules; and
 - (c) any special conditions (if applicable).
- 1.3 Capitalised terms used in this Agreement are defined in clause 24.
- 1.4 Each party acknowledges that it enters into this Agreement for the benefit of both the other party and the other party's Related Bodies Corporate (which, in the case of Origin, includes each Origin Company).
- 1.5 We hold the benefit of this Agreement (including the right to recover any Liability) for our self and on trust for each Origin Company and are entitled to enforce this Agreement (including any indemnity), whether by way of equitable, legal or statutory relief, for our self and on behalf of any Origin Company.

2. TERM

This Agreement commences on the date on which it has been executed by all parties and continues until it is terminated under clause 11 (**Term**).

3. ENM SERVICES

- 3.1 We will provide the ENM Services in respect of the Embedded Network from the ENM Services Start Date until the end of the Term (or such other period as may be agreed by us and you in writing).
- 3.2 We must provide the ENM Services in accordance with the National Electricity Rules and any other applicable Regulatory Requirements.

3.3 We will do all things reasonably within our control to ensure that we are, at all relevant times, accredited and registered as an Embedded Network Manager under the National Electricity Rules.

3.4 We may engage subcontractors to perform all or part of the ENM Services. However, if we do engage subcontractors for this purpose, we must ensure that the terms of this Agreement are complied with in relation to the provision of the ENM Services.

4. YOUR OBLIGATIONS

You must:

- 4.1 give us notice as soon as reasonably practicable if you will, or propose to, cease to operate the Embedded Network;
- 4.2 ensure you have, and continue to have, any registration, authorisation or exemption required in relation to the Embedded Network, including in accordance with the AER NSP Registration Guideline, as that document may be amended or replaced from time to time;
- 4.3 provide us with all information reasonably required or requested by us to enable us to carry out our role as the Embedded Network Manager for the Embedded Network; and
- 4.4 otherwise cooperate with, or provide such assistance to, us as we may reasonably require including in order to ensure compliance with any Regulatory Requirement relating to the ENM Services.

5. ELECTRICAL SCHEMATIC DRAWINGS

- 5.1 You must ensure that we are provided with the electrical schematic drawings for the Premises, as it was constructed, as soon as practicable and, in any event, prior to the ENM Services Start Date.
- 5.2 If the electrical schematic drawings for the Premises change, you must provide the updated electrical schematic drawings to us within 14 days of the change.

6. CONSIDERATION

- 6.1 As consideration for the provision by us of the ENM Services, you agree to satisfy each obligation imposed on you by this Agreement.
- 6.2 We will not charge you any fees for the provision of the ENM Services.
- 6.3 You will not seek, and we will not pay you, any payment in respect of the provision of ENM Services for the Embedded Network under this Agreement.

EMBEDDED NETWORK MANAGER SERVICES AGREEMENT
7. CHANGES OF LAW

- 7.1 If there is a Change of Law we may change the terms of this Agreement to the extent reasonably required as a result of the Change of Law.
- 7.2 We will give you notice of any changes to the terms, and the date they will apply from, as a result of Change of Law as soon as practicable. The changes may be retrospective back to the date of the Change of Law. We will provide, on your request, reasonable information and explanation about the changes.

8. COSTS OF COMPLIANCE

Each party will bear its own costs of complying with its obligations under applicable Regulatory Requirements, and in providing any cooperation and assistance required to be provided under the terms of this Agreement.

9. MUTUAL OBLIGATIONS

- 9.1 In performing its obligations under this Agreement, each party must:
- (a) comply with all Regulatory Requirements;
 - (b) not, by its act or omission, place the other party in breach of any Regulatory Requirement or Approval; and
 - (c) provide all things and take all measures necessary to protect people and property.
- 9.2 Any warranty or guarantee required by law to be incorporated into this Agreement is incorporated. Any warranty, guarantee or implied term which can be excluded by law is excluded.

10. PRIVACY

- 10.1 Each party must comply with the Privacy Act.
- 10.2 We may collect, hold, use and disclose Personal Information about you, applicable customers within the Embedded Network or Personnel disclosed to us in the course of performing this Agreement or performing our functions in relation to the Embedded Network in accordance with our Privacy Policy and the applicable privacy collection statements (see originenergy.com.au/privacy).

11. TERMINATION

- 11.1 This Agreement will automatically terminate and, to the extent permitted by applicable Regulatory Requirements, we will cease providing ENM Services, if:
- (a) you cease operating the Embedded Network;
 - (b) we cease to be registered and accredited as an Embedded Network Manager under the National Electricity Rules;
 - (c) the Embedded Network ceases to be subject to the Embedded Network Conditions (unless the parties agree in writing that the ENM Services should continue to be provided after that date in respect of the Premises);
 - (d) you have engaged another accredited and registered Embedded Network Manager to perform services equivalent to the ENM Services for the Embedded Network; or

- (e) either party gives the other 60 days' written notice of termination of this Agreement.

- 11.2 Termination of this Agreement is without prejudice to the rights of the parties occurring before the date of termination.

12. WARRANTIES

Each party represents and warrants that:

- 12.1 it validly exists under the law of the place of its incorporation, has the power to sign this Agreement and has all authority and rights needed to perform it;
- 12.2 all information it provides, or causes to be provided, to the other party is accurate, up to date and complete; and
- 12.3 the signing or performing of this Agreement will not breach, conflict with or infringe any other obligation, agreement, Regulatory Requirement or Encumbrance by which it is bound.

13. PARTNERSHIPS AND TRUSTS

- 13.1 If you are a partner in a partnership, each partner is jointly and severally liable under this Agreement.
- 13.2 If you enter this Agreement as a trustee you represent and warrant in your own right and as trustee of the Trust, that as at the date of this Agreement and until such time as all your obligations under this Agreement are discharged:
- (a) you are the sole trustee of the Trust;
 - (b) you have the requisite capacity and authority to enter this Agreement on behalf of, and to bind the beneficiaries of, the Trust and to perform all obligations under this Agreement pursuant to the documents governing that Trust; and
 - (c) you have the right to be fully indemnified out of the assets of the Trust in relation to this Agreement and the assets of the Trust are sufficient to satisfy all obligations of the Trust under this Agreement.

14. LIABILITY

- 14.1 Neither party nor its Representatives are liable, and must not make a claim against, the other party for any Excluded Loss in connection with or arising from this Agreement.
- 14.2 To the extent permitted by law, our total aggregate Liability to you in connection with or arising from this Agreement is limited to the replacement, or cost of replacement, of the ENM Services, or the supply of equivalent ENM Services.

15. DISPUTE RESOLUTION

- 15.1 All disputes must be dealt with in accordance with this clause 15.
- 15.2 The party claiming the dispute must give a written notice to the other party setting out particulars of the dispute (**Dispute Notice**).
- 15.3 If a dispute has not been resolved by the parties within 5 Business Days after service of the Dispute Notice (or such other period as is agreed by the parties), the dispute will be referred to the parties' respective senior management.

EMBEDDED NETWORK MANAGER SERVICES AGREEMENT

- 15.4 If for any reason the dispute has not been resolved within 4 weeks of the date the dispute was referred to the parties' senior management under clause 15.3, either party may commence court proceedings.
- 15.5 Pending the resolution or determination of a dispute, you and we must continue to perform our respective obligations under this Agreement.
- 15.6 Nothing in this clause 15 prevents a party from:
- seeking urgent interlocutory or declaratory relief where, in that party's reasonable opinion, that action is necessary to protect that party's rights; or
 - terminating this Agreement where it has a right under the Agreement to do so.
- 15.7 Notwithstanding anything to the contrary in this clause 15, if the National Electricity Rules require a dispute to be resolved in accordance with Chapter 8 of the National Electricity Rules, the parties will follow the dispute resolution process set out in that chapter of the National Electricity Rules.
- 16. CONFIDENTIALITY**
- 16.1 Each party must keep all Confidential Information confidential.
- 16.2 A party may disclose Confidential Information:
- with the other party's prior written consent;
 - on a confidential basis to its Representatives, advisers and insurers (or those of a Related Body Corporate) to the extent disclosure is reasonably required; or
 - if required by Regulatory Requirements or applicable stock exchange rules.
- 17. ASSIGNMENT**
- 17.1 We may assign, transfer or novate this Agreement to any of our Related Bodies Corporate by prior notice to you.
- 17.2 Otherwise, neither party may assign, transfer or novate this Agreement without the prior written consent of the other party (not to be unreasonably withheld).
- 18. FORCE MAJEURE**
- 18.1 A party will be excused for any non-performance of its obligations under this Agreement (other than an obligation to pay money) during the time and to the extent that Force Majeure prevents the party from doing so.
- 18.2 A party must:
- try to remove, overcome or minimise the effects of Force Majeure as soon as it can; and
 - give the other party prompt notice of the Force Majeure including details of its expected duration.
- 18.3 If the effects of such an event are widespread, we may give you prompt notice by making the necessary information available on a 24 hour telephone service promptly after becoming aware of the event.
- 19. LAWS APPLICABLE TO THIS AGREEMENT**
- 19.1 This Agreement is governed by the laws in force in the state or territory where the applicable Embedded Network is located.
- 19.2 Each party submits to the non-exclusive jurisdiction of the courts of that place.
- 20. VARIATIONS TO THIS AGREEMENT AND WAIVER**
- 20.1 Unless otherwise specified in this Agreement, any variations to the terms of this Agreement or any waiver of any rights of any party has no effect unless it is in writing and signed by the parties (in the case of a variation) or the party granting the waiver (in the case of a waiver).
- 20.2 A party's failure or omission to exercise, enforce or require strict or timely compliance with any provision of this Agreement does not affect or impair that provision, or the right of that party to avail itself of the remedies it may have in respect of any breach of that provision.
- 21. NOTICES**
- 21.1 A notice or other communication under this Agreement is only effective if:
- in writing and addressed to the person to whom it is given; and
 - sent to the relevant party's address for notices as specified in Schedule 1 or amended by a party by notice to the other party; or
 - sent by email to the email address notified by the relevant party to the other party.
- 21.2 A notice is given:
- if sent by email – 24 hours after the email was sent, unless the sender receives an automated message that the email was not delivered or knows the email was not delivered or could not be read; or
 - if sent by mail – if sent by priority mail, 3 Business Days after posting, or if sent by regular mail, 6 Business Days after posting.
- 22. ANTI-BRIBERY**
- 22.1 You must, and must ensure that your Representatives, comply with all applicable anti-bribery, fraud, secret commission and corruption laws.
- 22.2 You agree that you and your Representatives have not received, and will not receive, any payment, benefit or other thing of value (whether by way of gift, kickback or otherwise) in connection with this Agreement that is not legitimately due to you or your Representatives.
- 22.3 You must not, and must ensure that your Representatives do not, make any facilitation payment in connection with this Agreement.
- 23. GENERAL PROVISIONS**
- 23.1 This Agreement supersedes all prior and other negotiations, representations, proposals, understandings and agreements, whether written or oral, relating to the subject matter of this Agreement.

EMBEDDED NETWORK MANAGER SERVICES AGREEMENT

- 23.2 You acknowledge that you have not relied on any predictions, forecasts, advice or statements of opinion by us, or any of our employees or agents, as to the appropriateness or financial effect of this Agreement or market conditions.
- 23.3 Clauses 1, 11.2, 13, 16, 19, 21, 23, 25 survive termination or expiry of this Agreement. Other terms of this Agreement will survive termination or expiry of this Agreement where it is necessary for it to do so to enable a party to enforce a right accrued on or before termination or expiry.
- 23.4 It is not necessary for us to incur an expense or make a payment before enforcing a right of indemnity conferred by this Agreement.
- 23.5 If any part of this Agreement is unlawful, unenforceable or invalid, that part will be treated as removed from the Agreement, but the rest of the Agreement is not affected.

24. DEFINITIONS

The following definitions apply in this Agreement unless the context requires otherwise:

AEMO means the Australian Energy Market Operator Limited ABN 94 072 010 327.

AER NSP Registration Guideline means the guidelines published by the Australian Energy Regulator under clause 2.5.1 of the National Electricity Rules, as amended and updated from time to time.

Agreement means this Agreement, as further described in clause 1.1.

Agreement Date means the date on which this Agreement has been executed by the parties.

Agreement Terms means this document.

Approval means any licence, permit, consent, authorisation, approval, registration, determination, certificate, exemption, filing, notice, qualification or other requirement (and any conditions attached to any of them) of or issued by any Regulatory Authority that must be obtained, held or satisfied by a party to supply, perform, receive or use the services to be supplied, or perform that party's obligations, under this Agreement or otherwise in relation to this Agreement.

Australian Standards means the standards developed and approved by or on behalf of Standards Australia Limited ABN 85 087 326 690 and designated as an "Australian Standard".

Business Day means a day which is not a Saturday, Sunday or a state wide public holiday in the state in which the applicable Embedded Network is located.

Confidential Information means:

- this Agreement;
- all information (in whatever form and whether or not marked "confidential" disclosed or made available to a party by or on behalf of the other party or that comes to the knowledge of the receiving party under or by virtue of negotiating, executing or performing this Agreement; or
- all information a party derives or produces, whether in whole or in part, from the information disclosed under paragraphs (a) and (b).

Change of Law means a change in any Regulatory Requirement or Tax, or any variation in the interpretation, effect or administration of any Regulatory Requirement or Tax, taking effect after the Agreement Date, that has or will directly or indirectly affect the costs or benefits that we or one of our Related Bodies Corporate have or will incur, in connection with this Agreement, except that a Change of Law does not apply if the event in question relates to income tax as defined in the *Income Tax Assessment Act 1997* (Cth).

Dispute Notice has the meaning given in clause 15.2.

Embedded Network has the meaning given in paragraph B of the Background to this Agreement.

Embedded Network Manager has the meaning given to that term in the National Electricity Rules.

Encumbrance includes any mortgage, charge, pledge, lien, encumbrance, assignment, security interest, title retention, possessory right, preferential right, trust arrangement, contractual right of set-off or any other security agreement or arrangement in favour of any person by way of security for the payment of a debt or any other obligation.

ENM Conditions has the meaning given to that term in the National Electricity Rules.

ENM Services has the meaning given to the term "embedded network management services" in the National Electricity Rules.

ENM Services Start Date means the later of:

- the Agreement Date;
- the date specified in Item 1 of Schedule 1; and
- the date on which you become subject to the ENM Conditions in respect of the Embedded Network.

Excluded Loss means any:

- loss of contract, profit, revenue or anticipated savings;
- loss of or damage to, reputation, credit rating or goodwill;
- loss or denial of opportunity;
- loss of access to markets;
- overheads and wasted expenditure;
- financing costs;
- special, incidental or punitive damages; or
- any loss or damage arising from special circumstances that are outside the ordinary course of things,

however arising in respect of any circumstances under or in connection with this Agreement, and regardless of whether a claim for same is made under this Agreement, a Regulatory Requirement, tort, negligence, strict liability, under an indemnity or a warranty, in equity or otherwise.

Force Majeure means, with respect to an obligation of a party under this Agreement, any event or circumstance occurring on or after the commencement date of this Agreement that:

- is not within the reasonable control of that party;

EMBEDDED NETWORK MANAGER SERVICES AGREEMENT

(b) could not be prevented, overcome or remedied by the exercise of due diligence and Good Industry Practice by that party; and

(c) results in that party being unable to meet or perform that obligation or delays its ability to do so.

Good Industry Practice means, in relation to any activity, the exercise of that degree of skill, care, diligence, prudence, methods, practices, processes, workmanship and use of materials and equipment that would be reasonably exercised by a skilled and experienced person who:

(a) is engaged in the carrying out of activities of the same nature and extent as the relevant activity by reference to proper and prudent practices recognised internationally, but as applied to circumstances prevailing in Australia and to the operations contemplated by this Agreement;

(b) knows the facts that were known, or should reasonably have been known, to the person performing the activity at that time; and

(c) complies with all applicable Regulatory Requirements.

Liability includes any loss, damage, liability, cost, charges and expenses.

National Electricity Law means the National Electricity Law as set out in the schedule to the *National Electricity (South Australia) Act 1996* (SA), as applied in the state or territory in which the applicable Embedded Network is located.

National Electricity Rules means the National Electricity Rules made under the National Electricity Law, as applied in the state or territory in which the applicable Embedded Network is located.

Origin Company means Origin Energy Limited ABN 30 000 051 696 and any of its Related Bodies Corporate.

Personal Information has the meaning given in the Privacy Act.

Personnel means those persons who a party uses to perform that party's obligations, whether an employee, director, officer, representative, contractor, subcontractor, agent of or seconded to, that party or any of its Related Bodies Corporate or otherwise.

Privacy Act means the *Privacy Act 1988* (Cth).

Regulatory Authority means:

(a) any government or a governmental, quasi governmental or judicial entity or authority;

(b) a stock exchange; and

(c) any other authority, agency, commission, regulator, ministry, department, instrument, tribunal (including any pricing body), enterprise or similar entity,

that has powers or jurisdiction under any Regulatory Requirement over a party or any act relating to this Agreement.

Regulatory Requirement means:

(a) any act, regulation or other statutory instrument or proclamation of any applicable jurisdiction in which any act or obligation in connection with this Agreement is or is to be carried out or regulated;

(b) any applicable law, whether of a legislative, equitable or common law nature;

(c) any AEMO procedure or guideline;

(d) any applicable Australian Standards and codes (including voluntary codes with which we or any of our Related Bodies Corporate have committed to comply); and

(e) any judgment, decree or similar order with mandatory effect or any binding requirement or mandatory approval of a Regulatory Authority, including any Approval,

relevant to the performance of a party's obligations, under this Agreement or otherwise relevant to a party.

Related Body Corporate has the meaning given in the *Corporations Act 2001* (Cth).

Representative means a party's Personnel and any other officer, director, employee, representative, agent of or seconded to, a party or any of its Related Bodies Corporate.

Schedule means a schedule to these Agreement Terms.

Term has the meaning given in clause 2.

Trust means the trust identified in item 3 of Schedule 1 (if applicable).

25. INTERPRETATION

Unless otherwise stated:

(a) a reference to this Agreement or another document includes any variation or replacement of any of it;

(b) the singular includes the plural and vice versa;

(c) a reference to a statute, code or other law includes regulations and other instruments or directives under it and consolidations, amendments, re-enactments or replacements of any of them;

(d) a person includes any type of entity or body, whether or not it is incorporated or has a separate legal identity, and any executor, administrator, successor or permitted assigns;

(e) a reference to a body (other than a party) which ceases to exist, or whose powers or function are transferred to another body, is a reference to the body which replaces it or substantially succeeds to its powers or functions;

(f) specifying anything after the words "include" "including", "for example" or similar expressions does not limit what is included;

(g) the expression "relating to" and similar grammatical expressions includes arising from, concerning or in connection with (whether directly or indirectly);

(h) a reference to a Liability incurred or suffered by us includes Liabilities of our Related Bodies Corporate relating to the relevant matter; and

(i) a reference to a variation of a charge includes introducing a new charge.

SCHEDULE 1: Contract Details

Item 1: ANTICIPATED ENM SERVICES START DATE – 1st May 2021

Item 2: **ORIGIN'S DETAILS**

Origin Energy Retail Limited

ABN 22 078 868 425

Address for notices: GPO Box 186 Melbourne VIC 3001

Telephone number: 1800 684 993 (1800 002 438 for after hours and emergencies)

Email: embeddednetworks@originenergy.com.au

Representative: Mike Hamlin

Item 3: **PREMISES PARTY'S DETAILS**

Premises Party:

ABN:

Address for notices:

Telephone number:

Representative:

Item 4: **PREMISES**

Address of Premises: 200 Nottingham Rd Parkinson Qld 4115

Description of Premises: 29 Residential Townhouses

EXECUTED as an Agreement.

SIGNED for and on behalf of **Origin Energy Retail Limited ABN 22 078 868 425** by its duly authorised representative in the presence of:

Signature of witness

Name of witness

Signature of authorised representative

Name of authorised representative

Title of authorised representative

Date _____

The Common Seal of _____
[insert full name of Owners Corporation]

ABN _____ [insert]
was affixed in the presence of:

Signature of Secretary

Name of Secretary

Signature of Chairman

Name of Chairman

Date _____